

midi LOGGER GL840

Quick Start Guide

604849020 GL840-UM-850



GRAPTEC

Thank you for choose the midi LOGGER GL840.
This Quick Start Guide describes the basic operations.
Please refer to the manual (PDF) in the CD-ROM for more information.

Checking the Outer Casing

After unpacking, check the GL840's Exterior to make sure that there are crack or other damage before use.

Checking the Accessories

- Quick Start Guide : 1
- SD memory card: 1
- Ferrite core: 1
- CD-ROM : 1
- AC cable/AC adapter : 1

Contents

Nomenclature	2
Connection Procedures	3
Precautions to Observe When Performing Measurement	5
Descriptions of the Control Panel Keys	7
Descriptions of the Menu Screens	10
Measurement Procedure	11
1. Preparations :	
How to Make the Preparations Required for Data Capture	11
2. Setup : How to Make the Settings	12
3. Data Capture : How to Capture Data	15
4. Data Replay : How to Replay Captured Data	16
Convenient Functions	17
Trigger Functions to Control Data Capture Start/Stop Operations	17
Span, Position and Trace Functions to Adjust the Waveform Display	19
Specifications	20
Standard Specifications	20
External Input/Output Functions	20
Common specification of the terminal in the input section	21
Specification of input section (GL840-M with standard terminal)	21
Specification of input section (GL840-WV Withstand High Voltage high-precision terminal) ...	22
Installation Guide	22

Nomenclature

Top Panel

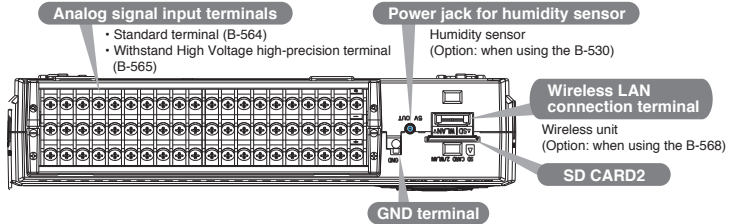

Front Panel

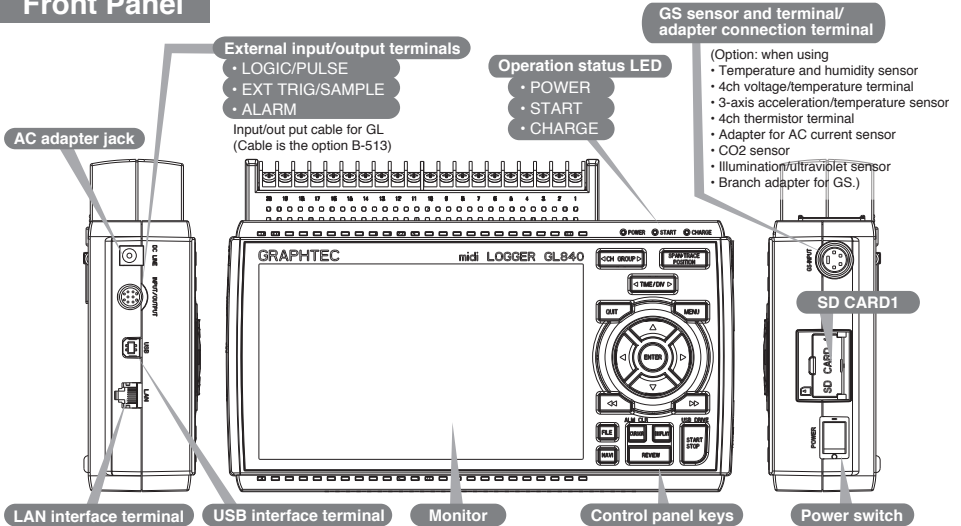

Bottom Panel

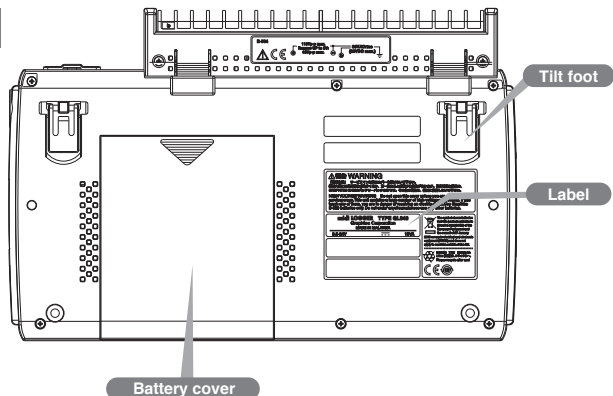

Two battery pack can be installed
(Battery pack is the option B-569)

Connection Procedures

Connecting the AC Adapter

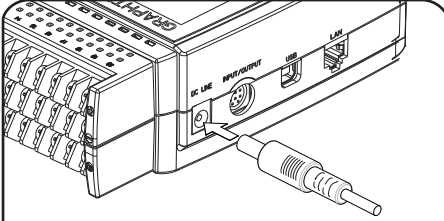

Connect the DC output of the AC adapter to the connector indicated as "DC LINE" on the GL840.

Connecting the Grounding Cable

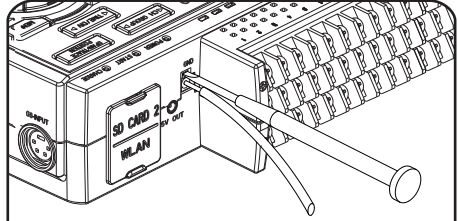

Use a flathead screwdriver to push the button above the GND terminal while connecting the grounding cable to the GL840. Connect the other end of the cable to ground.

Making Connections to the Analog Input Terminals

Voltage input
 +
 DC voltage input
 -

Thermocouple input
 +
 Compensation wire is used if it is required.

Resistance temperature detector input
 A +
 B -
 b

Lead wire resistance should be 10 Ω or less per wire, three wires need to be same length.

Current input
 +
 -

Shunt resistor
 Ex: The current is converted to the voltage in the shunt register.
 For 4 to 20mA current input, installing 250 ohms (0.1%) resistor for converting 1 to 5V.
 Note: 250 Ω shunt register is the option B-551.

CAUTION: Connect wires to the specified channel, the channel number is shown on top of the terminal block.

Making Connections to the External Input/Output Terminals

< Signal assignment >

Orange with red dotted line	: 1	Logic/pulse input
Orange with black dotted line	: 2	
Grey with red dotted line	: 3	
Grey with black dotted line	: 4	
White with red dotted line	: 1	Alarm output
White with black dotted line	: 2	
Yellow with red dotted line	: 3	
Yellow with black dotted line	: 4	
Pink with red dotted line	: 1	Trigger input/ external sampling input
Pink with black dotted line	: 2	
Shielded		GND

* The B-513 input/output cable for GL (sold separately) is required for connecting input/output signals.
 (For logic/pulse input, alarm output, trigger input, external sampling pulse input)

Mounting of the SD CARD 1

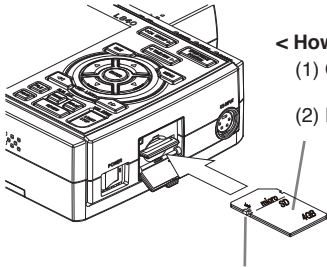

< How to mount >

- (1) Open the protective cover of SD CARD 1.
- (2) Push the SD memory card until it clicks and is locked.

< How to remove >

- (1) The SD memory card is unlocked by pushing gently the SD memory card. Then, remove the SD memory card.

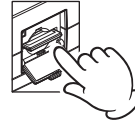

*** Make sure that the SD memory card is not locked.**

CAUTION: When removing the SD memory card, make sure that the SD card display on the display is green and then remove it.

Mounting of the SD CARD 2

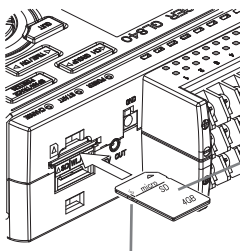

< How to mount >

- (1) Open the protective cover of SD CARD 2.
- (2) Push the SD memory card until it clicks and is locked.

< How to remove >

- (1) The SD memory card is unlocked by pushing gently the SD memory card. Then, remove the SD memory card.

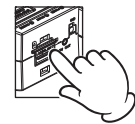

*** Make sure that the SD memory card is not locked.**

CAUTION: The SD memory card is unlocked by pushing gently the SD memory card. Then, remove the SD memory card.
When the optional wireless LAN unit is installed, the SD memory card cannot be mounted.

Connection of the USB cable

When connecting to the PC with the USB cable, attach the supplied ferrite core to the USB cable as shown in the following figure.

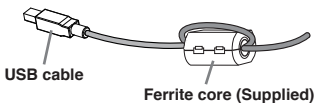

Using the cable with A-type and B-type connectors, connect between the midi LOGGER and PC.

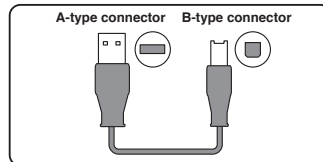

This midi LOGGER complies with the EMC Directive in the state when the supplied ferrite core is attached to the USB cable.

When connecting with the USB cable, the USB driver must be installed to the PC. For information about how to install, refer to the "USB Driver Installation Manual" in the supplied CD-ROM.

Precautions to Observe When Performing Measurement

Maximum input voltage of standard terminal (B-564)

If a voltage exceeding the specified value is input, the semiconductor relay in the input section will be damaged. Never input a voltage exceeding the specified value even for a moment.

< Between +/- terminals(A) >

- Maximum input voltage: 60Vp-p (Range of 20mV to 2V)
110Vp-p (Range of 5V to 100V)

< Between input terminal/input terminal (B) >

- Maximum input voltage: 60Vp-p
- Withstand voltage: 350 Vp-p at 1 minute

< Between input terminal/GND (C) >

- Maximum input voltage: 60Vp-p
- Withstand voltage: 350 Vp-p at 1 minute

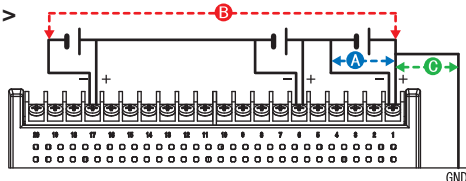

Maximum input voltage of Withstand High Voltage high-precision terminal (B-565)

If a voltage exceeding the specified value is input, the semiconductor relay in the input section will be damaged. Never input a voltage exceeding the specified value even for a moment.

< Between +/- terminals(A) >

- Maximum input voltage: 60Vp-p (Range of 20mV to 2V)
110Vp-p (Range of 5V to 100V)

< Between input terminal/input terminal (B) >

- Maximum input voltage: 600Vp-p
- Withstand voltage: 600Vp-p

< Between input terminal/GND (C) >

- Maximum input voltage: 300Vp-p
- Withstand voltage: 2300 VACrms at 1 minute

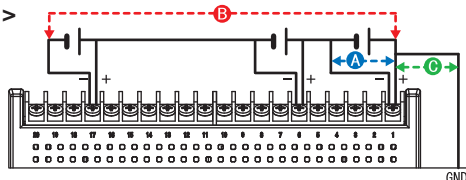

Warming-up

GL840 requests to have approximately 30 minutes warm-up in order to have the specified performance.

Unused channels

The analog input section has high impedance.

If it is open, measured value may vary due to noise.

In such a case, set to "Off" unused channels in the AMP setting menu or short the + and - terminals.

Noise countermeasures

If measured values fluctuate due to extraneous noise, conduct the following countermeasures. (Results may differ according to noise type.)

Ex 1 : Connect the GL840's GND to ground.

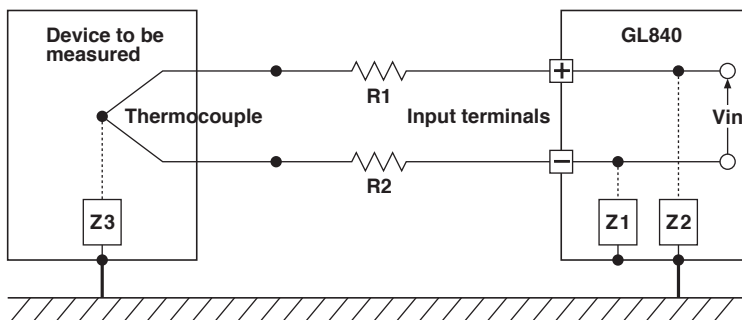

Ex 2 : Connect GL840's GND to measurement object's GND.

Ex 3 : Operate GL840 with batteries (Option: B-568).

Ex 4 : In the AMP settings menu, set filter to any setting other than "OFF".

Ex 5 : Set the sampling interval which enables GL840's digital filter
(see table below).

Number of Measuring Channels *1	Allowed Sampling Interval	Sampling Interval which enables Digital Filter
1 channel or less	10 msec or slower *2	50 msec or slower
2 channels or less	20 msec or slower *2	125 msec or slower
5 channels or less	50 msec or slower *2	250 msec or slower
10 channels or less	100 msec or slower	500 msec or slower
11 to 20 channels	200 msec or slower	1 sec or slower
21 to 50 channels	500 msec or slower	2 sec or slower
51 to 100 channels	1 sec or slower	5 sec or slower
101 to 200 channels	2 sec or slower	10 sec or slower

*1 Number of Measuring Channels is the number of channels in which input settings are NOT set to "OFF".

*2 Temperature cannot be measured when the sampling interval is set to 10 ms/20 ms or 50 ms.

In the "OTHER" menu, the commercial power frequency to be used must be set.

Set the AC power frequency to be used.

Select items	Description
50 Hz	Area where the power frequency is 50 Hz
60 Hz	Area where the power frequency is 60 Hz

Descriptions of the Control Panel Keys

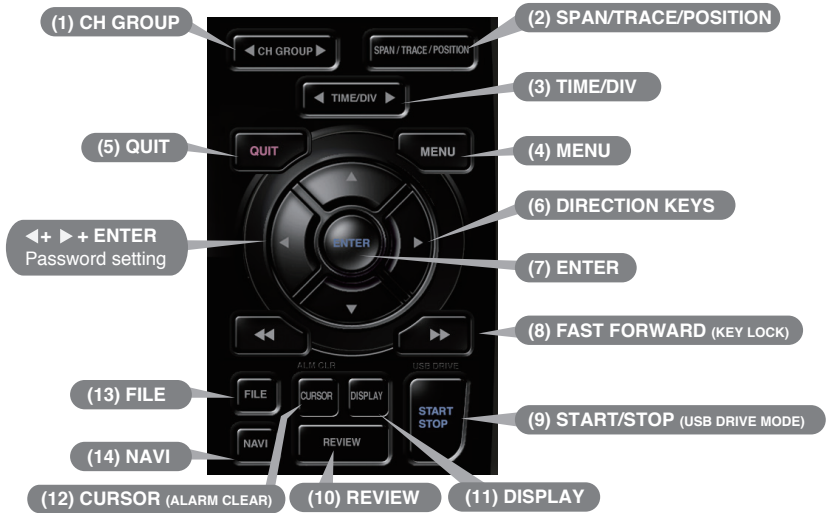

1. CH GROUP

Press this key to switch to the next group consisting of 10 channels.
 Press the ◀ key to switch to the previous group.
 Press the ▶ key to switch to the following group.

* When installing the GS sensor and terminal/module (sold separately), the following group display is viewed.

2. SPAN/TRACE/POSITION

This key enables SPAN, POSITION, and TRACE settings to be made independently for each channel. Each time this key is pressed, the display mode changes in the sequence shown below. Use the ▲ and ▼ keys to select the channel, and the ◀ and ▶ keys to change the setting values.

Points to Remember

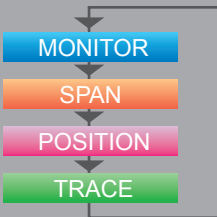

Displays digital values (default).

Used to change span settings (change the waveform amplitude).

Used to change position settings (adjust the upper and lower values of the waveform).

Used to change trace settings (set the waveform display to On or Off).

* If the QUIT key is pressed when the GL840 is in the SPAN, POSITION, or TRACE mode, the display returns to MONITOR mode.

3. TIME/DIV

Press the [TIME/DIV] key to change the time axis display range on the waveform screen.

4. MENU

Press the [MENU] key to open a setup menu. Each time this key is pressed, the setup screen tabs change in the sequence shown below.

Points to Remember

```
graph TD; AMP[AMP] --> DATA[DATA]; DATA --> TRIG[TRIG]; TRIG --> IF[I/F]; IF --> WLAN[WLAN]; WLAN --> OTHER[OTHER]; OTHER --> AMP;
```

- **AMP Settings**
Used to set the input, range, filter and other settings.
- **Data Capture Settings**
Used to set settings such as the sampling interval, data capture destination, and calculations during data capture.
- **Trigger Settings**
Used to specify data capture start and stop conditions, and alarm conditions.
- **Interface Settings**
Used to set the device ID in the USB and the IP address for the LAN.
- **Wireless LAN setting (displayed when the option is installed)**
Used to set the connection to the wireless LAN after the wireless unit is installed.
- **Other Settings**
Used to set the screen brightness, background color, and language, etc.

5. QUIT (LOCAL)

Press the [QUIT] key to cancel the settings and return them to their default status. If the device is in the Remote (Key Lock) status that the device is operated by the computer via the interface, press this key to return the device to the normal operating status (Local).

6. Keys (DIRECTION KEYS)

These keys are used to select menu setup items, to make span settings in the digital display area, to move the cursors during a data replay operation, and so forth.

7. ENTER

Press the [ENTER] key to enter the settings made in the setup menus, and to confirm your settings.

8. Keys (KEY LOCK)

These keys are used when you want to move the cursor quickly during replay or change the display mode on the “Digital + Operation” screen. Hold down both keys simultaneously for at least two seconds to enable key lock status.

To cancel key lock status, press them again for at least two seconds.

The key lock status can be confirmed by the status of the key lock lamp on the monitor.

* Pressing these keys simultaneously with the ◀ key + ENTER + ▶ key enables password protection for the key lock operation.

9. START/STOP (USB DRIVE MODE)

Press the [START/STOP] key to perform start and stop of a data capture while the GL840 is in the Free Running status.

If this key is held down while the power to the GL840 is turned on, the GL840 is switched the SD memory card to the Drive Mode.

* For more information about the Drive Mode of the SD memory card, refer to the User's Manual in the supplied CD.

10. REVIEW

Press the [REVIEW] key to replay captured data. If the GL840 is in the Free Running status, data files that have already been captured are replayed. If the GL840 is still capturing data, the data is replayed in a 2-screen format.

* A data replay operation will not be performed if data has not been captured.

11. DISPLAY

Press the [DISPLAY] key

Points to Remember

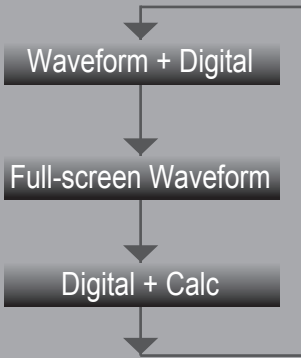

● Waveform + Digital

This is the default screen when the GL840 is turned on, and both waveforms and digital values are displayed. The screen settings can also be changed by using the [SPAN/TRACE/POSITION] key.

● Full-screen Waveform

Displays waveform only in the full-screen.

● Digital + Calc

Displays large-size digital values and two types of calculation processing results. The calculation settings are made in the "DATA" menu. Use the ◀◀ key or ▶▶ key to switch digital display modes.

* For more information, refer to the User's Manual in the supplied CD.

12. CURSOR (ALARM CLEAR)

Press the [CURSOR] key to switch between the A and B cursors during a data replay operation.

If the Alarm setting has been specified as "Alarm Hold", press this key to clear the alarm.

The alarm settings are made in the "TRIG" menu.

13. FILE

Press the [FILE] key to operate saving the replaying data to the SD memory card, copying the screen, and saving/reading the settings as well as replacing the SD memory card during data capture.

14. NAVI

When this key is pressed during free-running, you can perform the setting easily on the menus of the easy capture setting, easy trigger setting, and wireless LAN connection setting (available only when the wireless unit is inserted.).

Descriptions of the Menu Screens

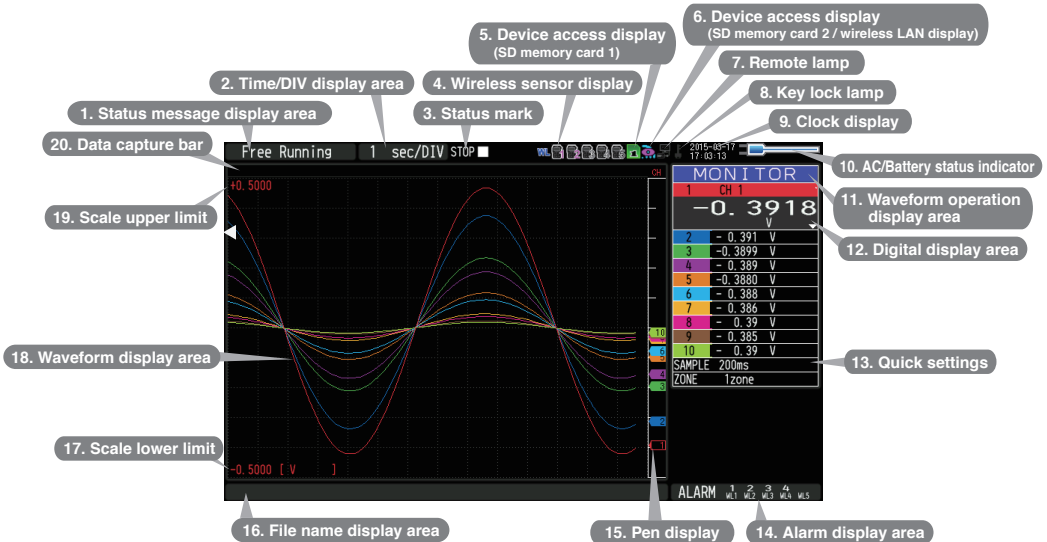

1. **Status message display area** : Displays the operating status.
2. **Time/DIV display area** : Displays the current time scale.
3. **Status mark** : Displays the status mark.
4. **Wireless sensor display** : Displayed when connecting the GL100-WL (GS sensor and terminal / module connection) to the wireless LAN.
5. **Device access display (SD memory card 1)** : Displayed in red when accessing the SD memory card 1. When the SD memory card 1 is inserted, it is displayed in green.
6. **Device access display (SD memory card 2 / wireless LAN display)** : Displayed in red when accessing the SD memory card 2. When the SD memory card 2 is inserted, it is displayed in green. (When connecting to the wireless LAN as a child unit, the radio field intensity of the base unit is displayed. When setting to the base unit, the number of child units (wireless sensor) which are connecting to the GL840 is displayed.)
7. **Remote lamp** : Displays the remote status. (Yellow = Remote status, white = Local status)
8. **Key lock lamp** : Displays the key lock status. (Yellow = keys locked, white = not locked)
9. **Clock display** : Displays the current date and time.
10. **AC/Battery status indicator** : Displays the following icons to indicate the operating status of the AC power and the battery. (see right figure)
Note: Use this indicator as a guideline because remaining battery power is an estimate. This indicator does not guarantee the operating time with battery.
11. **Waveform operation display area** : Displays the mode selected by the [SPAN/TRACE/POSITION] key.
12. **Digital display area** : Displays the input values for each channel. The ▲ and ▼ keys can be used to select the active channel (enlarged display). Moreover, the selected active channel is displayed at the very top of the waveform display.

Status mark

STOP	Free Running status
REC	Trigger waiting status Capture end status
REC	Capturing recording status
PLAY	Data replay status

Status icon

Radio field intensity display of base unit (5 stages from Strong to Weak)

When setting to base unit: The number of child units which are connecting to the GL840 is displayed.

Wireless sensor unregistration display
Wireless sensor registration / unrecognition display
Wireless sensor registration / recognition display

AC/Battery Indicator

When the AC power supply is being used

	Battery power: 100 - 91%
	Battery power: 90 - 61%
	Battery power: 60 - 31%
	Battery power: 30 - 11%
	Battery power: 1% or less

- 13. Quick settings : Displays items that can be easily set. The ▲ and ▼ keys can be used to make a Quick settings item active, and the ◀ and ▶ keys to change the values.
- 14. Alarm display area : Displays the status of the alarm output. (Red = alarm generated, white = alarm not generated)
- 15. Pen display : Displays the signal positions, trigger positions, and alarm ranges for each channel. (see right figure)
- 16. File name display area : Displays the data capture file name during the data capture operation. When data is being replayed, the display position and cursor information are displayed here.
- 17. Scale lower limit : Displays the lower limit of the scale of the currently active channel.
- 18. Waveform display area : The input signal waveforms are displayed here.
- 19. Scale upper limit : Displays the upper limit of the scale of the currently active channel.
- 20. Data capture bar : Indicates the remaining capacity of the capture media during data capture. When data is being replayed, the display position and cursor information are displayed here.

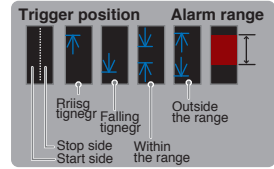

Measurement Procedure

In this section we will provide a simple explanation of the data capture procedure:
Preparations -> Setup -> Data Capture -> Data Replay.

Voltage measurement is performed here.

Purpose of data capture : To measure the temperature of the target objects

Temperature Range : T type Thermocouple, 100°C

Voltage range : 1V

Sampling interval : 1 sec

Data save destination : SD1 (SD CARD1)

1. Preparations : How to Make the Preparations Required for Data Capture

1. Connect Thermocouple to the CH 1 terminal (Temperature).
2. Connect wire to the CH 2 terminal (Voltage).
3. Connect the AC power supply.
4. Turn on the power supply.

Connect securely!

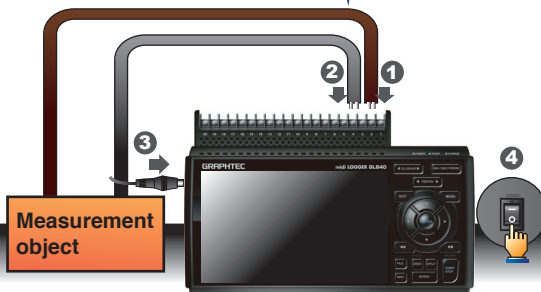

2. Setup : How to Make the Settings

Make the settings required for data capture. Here we will make only those settings that are minimum requirement. The other settings will be not changed from the factory default settings.

Points to Remember

Basic Setup Menu Operation

The \blacktriangle , \blacktriangledown , \blacktriangleleft , \blacktriangleright , [ENTER], and [QUIT] keys are used to set the condition on the setup menu. The current position of the cursor on the setup menu is displayed in green.

Use the \blacktriangle , \blacktriangledown , \blacktriangleleft , \blacktriangleright keys to move the cursor. If you press the [ENTER] key at the cursor position, a selection menu or a box of entering value for selected item is displayed.

If you press the [QUIT] key, the screen closes and the settings are canceled.

• Examples of selection menu operations (AMP screen)

1. Use the \blacktriangle , \blacktriangledown , \blacktriangleleft , \blacktriangleright keys to move the cursor to the Input parameter of CH 1 and then press the [ENTER] key.

CH :	Input	Sensor	Range
ALL: M	DC		2 V
1: M	DC		2 V
2: M	OFF		5 V
3: M	DC		2 V
4: M	TEMP		5 V
5: M	RH		2 V
6: M	UL		5 V

2. A selection menu is displayed when the [ENTER] key is pressed. Use the \blacktriangle and \blacktriangledown keys to select "TEMP".

CH :	Input	Sensor	Range
ALL: M	DC		2 V
1: M	TEMP		2 V
2: M	OFF		5 V
3: M	DC		2 V
4: M	TEMP		5 V
5: M	RH		2 V
6: M	UL		5 V

3. Press the [ENTER] key to confirm your selection.

CH :	Input	Sensor	Range
ALL: M	TEMP	TC-K	2000°C
1: M	TEMP	TC-K	2000°C
2: M	DC		5 V
3: M	DC		2 V
4: M	DC		5 V
5: M	DC		2 V
6: M	DC		5 V

(Note: Select "DC" for voltage measurement, and "Humidity" for humidity measurement.)



1. Press the [MENU] key to display the setup menu screen.

2. Set Input to "TEMP" and Sensor to "TC-T" for CH1, and set Input to "DC" and Range to "1V" for CH2.

- (1) Move the cursor to CH1 "Sensor" and select "TC-T" and then move it to "Range" and select "100°C".

CH :	Input	Sensor	Range	Filter	EU	Misc.
ALL: M	TEMP	TC-T	100.0°C	OFF	OFF	OFF
1: M	TEMP	TC-T	100.0°C	OFF	OFF	OFF
2: M	DC	DC	1.000 V	OFF	OFF	OFF
3: M	DC	P100	OFF	OFF	OFF	OFF
4: M	DC	P100	OFF	OFF	OFF	OFF
5: M	DC	TC-S	OFF	OFF	OFF	OFF
6: M	DC	TC-S	OFF	OFF	OFF	OFF
7: M	DC	TC-S	OFF	OFF	OFF	OFF
8: M	DC	TC-S	OFF	OFF	OFF	OFF
9: M	DC	TC-S	OFF	OFF	OFF	OFF
10: M	DC	TC-S	OFF	OFF	OFF	OFF

Select with \blacktriangle , \blacktriangledown and [ENTER] key.

- (2) In the same way, move the cursor to CH2 "Input" and select "DC" and then move it to "Range" and select "1V."

3. Select "Off" for all the other channels.

- (1) Using the procedure described above, select "Off" for CH 3 to CH 10. Use the [CH GROUP] key to switch to the CH11 to CH20 group.

CH :	Input	Sensor	Range	Filter	EU	Misc.
ALL: M	TEMP	TC-T	100.0°C	Off	Off	Off
1: M	TEMP	TC-T	100.0°C	Off	Off	Off
2: M	DC		1 V	Off	Off	Off
3: M	Off					
4: M	Off					
5: M	Off					
6: M	Off					
7: M	Off					
8: M	Off					
9: M	Off					
10: M	Off					



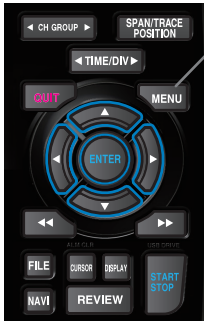

4. Press the [MENU] key and open the "DATA" menu.

Press the [MENU] key. Next, move the cursor to the "DATA" in the "MENU" at the top.

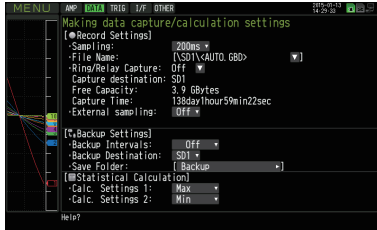

5. Set the sampling interval to "1s".

Move the cursor to "Sampling" and then select "1s".

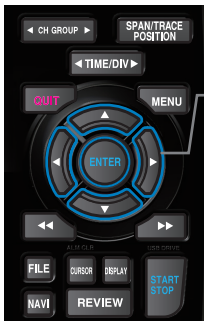
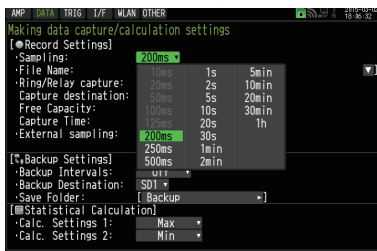

6. Set the Data Capture Destination to "SD memory card".

Here the "TEST" folder is created in the <SD1>, and then destination for the captured data is set to the TEST folder.

- (1) Move the cursor to the File Name parameter and then press the [ENTER] key.
- (2) Move the cursor to the <SD1> item in the following screen, press the [ENTER] key.

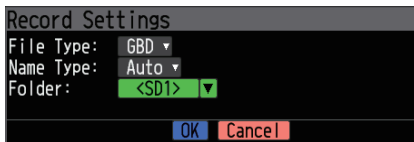

- (3) The file settings box shown in the following screen opens. In the file box, set the file name to record in the SD memory card.

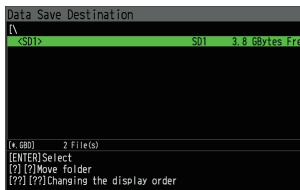

* The remaining memory capacity is indicated in the <SD1> when the SD memory card is mounted. When the SD memory card is not mounted, 0 Bytes is indicated.

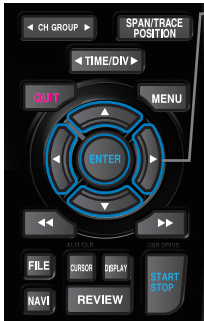

(4) Go to the "SD1" level using the ► key.

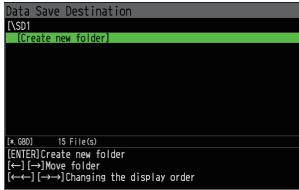

Move the cursor to the "Create New Folder" icon using the ▲▼ keys and then press the [ENTER] key. The Input menu is displayed.



(5) A text input box is displayed. Let's create a folder named "TEST".

(1) In the text type select; delete; insert; confirm items, move the cursor to the A using the ◀ and ► keys.

(2) The selected text is displayed.

In the text select, move the cursor to the text using the ▲, ▼, ◀ and ► keys and then press the [ENTER] key.

Input "TEST", move the cursor to [OK], and then press the [ENTER] key to enter your setting.

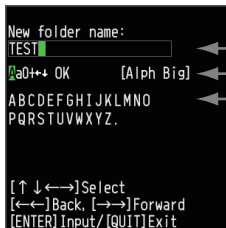

Text input box

(1) Select the text type, delete, insert, confirm

(2) Select the character

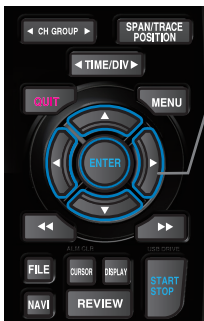

(6) Select the "TEST" folder and then press the [ENTER] key to return to the Capture setting screen.

(7) Move the cursor to [OK] and then press the [ENTER] key.



The data is recorded with the automatic file naming in the <TEST> folder of the mounted SD memory card.

(8) Available space in specified memory device and time for data capture are displayed in the lower part of the Record Settings menu. The data capture time can be checked.



Minimum required setting for data capture is completed.

3. Data Capture : How to Capture Data

All of setting for the data capture have been set, capturing data can be started now. During the data capture operation, let's also replay some data that was captured previously.

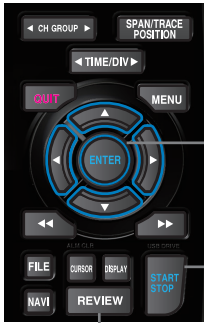

1. Starting data capture

- (1) Press the [START/STOP] key.
- (2) A confirmation message is displayed.

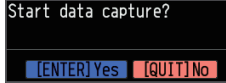

- (3) Press the [ENTER] key to start data capture.

2. Screen status during data capture

Once data capture has started, progress of data capture is shown. The displayed time is counting up or down.

capturing message



elapsed time

remaining time for data capture

(The indication becomes ++++ when the data capture time is 9999 hours or more.)

Points to Remember

Data can be replayed while being captured by pressing the [REVIEW] key.
 Data can be replayed during the data capture operation from the beginning to the point that has been captured.
 During the replay, you can check arbitrary level values and such by moving the cursor.
 You can return to the data capture screen by pressing the [REVIEW] key again.

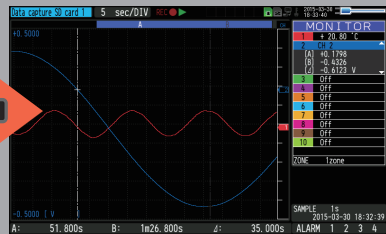

3. Stopping data capture

Press the [START/STOP] key to end the data capture operation.

- (1) Press the [START/STOP] key.

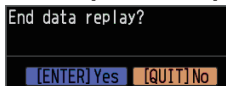

- (2) A confirmation message is displayed. Press the [ENTER] key.
- (3) Data capture ends, and the GL840 goes into the Free Running status.

The operation of data capture is completed.

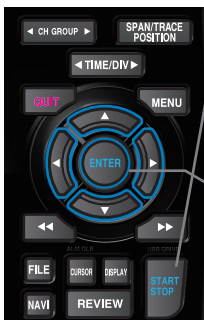

4. Data Replay : How to Replay Captured Data

When data capture ends, data is automatically replayed.

The automatically replayed data is the data captured to the SD memory card which has been set as the data capture destination.

Press the [QUIT] key to end the data replay operation.



1. Selecting a file to replay

- (1) Press the [REVIEW] key.
- (2) Since the file you want to replay has the file name that was appended automatically when the data was captured, move the cursor to the [OK] button and then press the [ENTER] key.

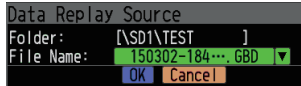

- (3) The Replay screen opens.

2. Replay screen

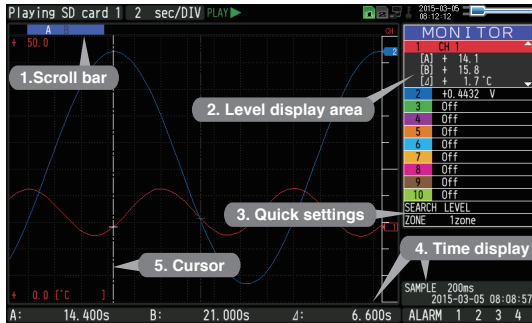

- (1) **Scroll bar** : Displays the position within the whole data and the display width.
- (2) **Level display area** : Displays the levels of A and B cursors and the difference between the A and B values.
- (3) **Quick settings** : Use the ◀▶ keys to search the previous or next level. (Note: Make search settings in the menu.)
- (4) **Time display** : Displays the sampling interval and the time of the cursor.
- (5) **Cursor** : Displays the cursor. (Note: Press the CURSOR key to switch between A and B cursors.)
Move the cursor using the ◀▶ keys or the ◀◀▶▶ keys.
Desired level values and time can be checked by moving the cursor.

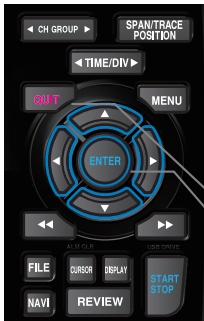

- Press the [QUIT] key to end the data replay operation.
- A confirmation message is displayed. Press the [ENTER] key.

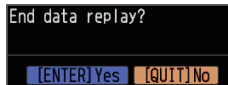

Data replay ends, and the GL840 goes into the Free Running status.

Explanation of basic operation in the GL840 is completed.

The GL840 has many other convenient functions. Please refer the next five pages for details.

Convenient Functions

The GL840 has various functions that enable it to be used more effectively. The selected three functions are described with details in the following.

Trigger Functions to Control Data Capture Start/Stop Operations

Trigger functions can be used to control the timing of the start of a data capture operation, and the timing of the end of a data capture operation.

Points to Remember

For example...

The trigger function performs operations such as the following:

- Start data capture when the voltage exceeds 1 V
- Stop data capture at 1:00 pm
- Perform control via external input

The example of the data capture start in the temperature setting conditions is described below.



Here data capture is started in the condition as "Start data capture when the CH 1 temperature exceeds 20°C".

(1) Press the [MENU] key and open the "TRIG" menu.

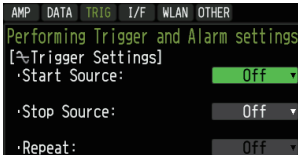

(2) Move the cursor to "Start Source" and select "Level".



(3) Press the [ENTER] key according to the "Level Settings" . The "Trigger Level Settings" screen is displayed. Move the cursor to the "Mode" parameter for the CH1, and then select "Hi".

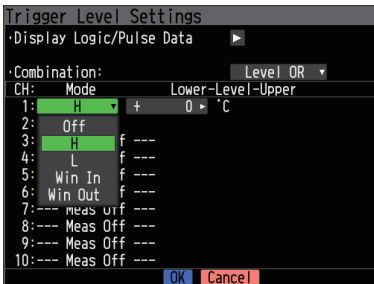



- (4) Move the cursor to the "Level" parameter next to the "Mode" parameter and then press the [ENTER] key.
- (5) The input box shown in the following screen is displayed. Select "20". Use the ◀ and ▶ keys to move to the cursor to the second digit from the right, and the ▲ and ▼ keys to change the value. Press the [ENTER] key.



- Numerical value input box
- Lower and upper limit for setting.
- Waveform area for confirmation Lower
- Use the ▲ and ▼ keys to change the values.
- Use the ◀ and ▶ keys to move the digit.
- Use the [ENTER] key to enter the value.
- Use the [QUIT] key to cancel the setting.

- (6) When the screen changes to the following screen, move the cursor to the **OK** button and then press the [ENTER] key.

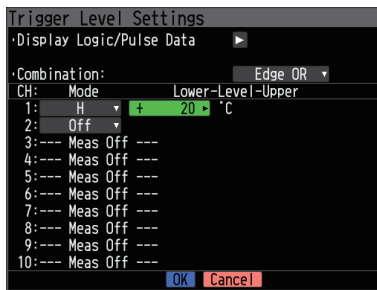

- (7) The screen returns to the TRIG menu screen. Press the [QUIT] key to return the GL840 to the Free Running status.
- (8) Press the [START/STOP] key to start data capture. If the trigger condition has not been satisfied, the QL840 goes into the "Armed" status as shown on the following screen.



When the trigger condition is satisfied, the recording is started after the display is changed to the "Data capture SD card 1" .

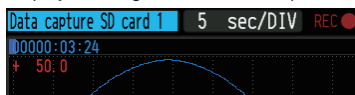

Points to Remember

The trigger of this trigger function can be set easily from the "Easy trigger setting" menu in the navigation displayed by pressing the [NAVI] key.

Span, Position and Trace Functions to Adjust the Waveform Display

Trigger functions can be used to control the timing of the start of a data capture operation, and the timing of the end of a data capture operation.

Points to Remember

The span, position and trace operations can be performed while the GL840 is in the Free Running status, while it is capturing data, and while it is replaying data. The changes are applied to the displayed data only, the change is not affected to the captured data.

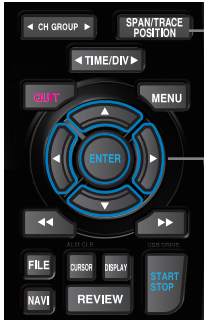

1. How to Make a Span setting

The Span parameter is used to adjust the amplitude of the input waveform. This setting is made in the aforementioned Free Running status.

- (1) Set the displayed span for CH 1 to 100°C.
- (2) Press the [SPAN/TRACE/POSITION] key to select the SPAN mode.

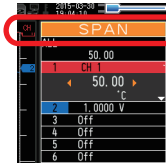

Points to Remember

The currently selected mode (SPAN, POSITION or TRACE) can be checked by looking at the "Waveform Operation Display Area".

- (3) Use the ▲ and ▼ keys to make CH 1 active (enlarged display).
- (4) Use the ◀ and ▶ keys to change the Span value. Here the value for span is set to 110°C.

When this setting has been changed, the waveform screen scale will be set to "+110.0 to +0.0".

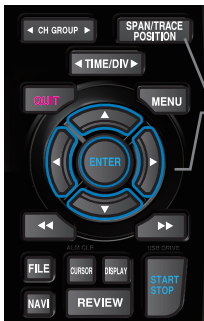
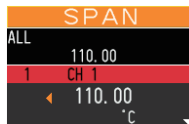

2. How to make a Position setting

The Position parameter is used to adjust the position of displayed waveform that is set by the upper and lower values.

- (1) Press the [SPAN/TRACE/POSITION] key to select the POSITION mode.
- (2) Use the ▲ and ▼ keys to make CH 1 active (enlarged display).
- (3) Use the ◀ and ▶ keys to set the Position value to "+90°C to -20°C".

When this setting has been changed, the waveform screen scale will be set to "+90°C to -20°C".



3. How to make a Trace setting.

The Trace parameter can be used to specify the selected waveform to be visible or invisible on the display.

- (1) Press the [SPAN/TRACE/POSITION] key to select the TRACE mode.
- (2) Use the ▲ and ▼ keys to make CH 1 active (enlarged display).
- (3) Use the ◀ and ▶ keys to select Off.

When this setting has been changed, the CH 1 waveform is not displayed.



Specifications

Standard Specifications

Item	Description																				
Number of analog channel	GL840-M or GL840-WV (20ch per 1 terminal or maximum 200ch available with extension unit)																				
External input and output functions	Trigger input and External sampling (1ch), Logic input (4ch) or Pulse input (4ch), Alarm output (4ch)																				
PC interface	Ethernet (10BASE-T/100BASE-TX), USB (HighSpeed supported) provided as standard features																				
Built-in memory device	SD memory card slot: 2 slots SD memory card: 4GB (standard supplied one card), however one file can be data-captured up to 2GB.																				
Number of analog channel	10ms/1ch MAX (GBD/CSV format) 10/20/50/100/125/200/250/500ms, 1/2/5/10/20/30sec 1/2/5/10/20/30min, 1hour, External * Allowable setting varies with the input setting and the number of measurement channels.																				
Back-up functions	Setup parameters: EEPROM/Clock: Lithium battery																				
Clock accuracy (ambient temperature 23°C)	±0.002% (approx. 50 seconds per month)																				
Operating environment	0 to 45°C, 5 to 85%RH (0 to 40°C when operated in batteries/15 to 35°C when battery is charging)																				
Power supply	AC adapter : 100 to 240 VAC, 50 to 60 Hz DC input : 8.5 to 24 VDC (26.4 V max.) Battery pack (option) : 7.2 VDC (2900 mAh), two packs required																				
Power consumption	AC power consumption * when using the AC adapter provided as a standard accessory																				
	<table border="1"> <thead> <tr> <th>No</th> <th>Condition</th> <th>Normal</th> <th>During recharging battery</th> </tr> </thead> <tbody> <tr> <td rowspan="2">1</td> <td rowspan="2">When the LCD is on</td> <td>AC100 V</td> <td>24 VA</td> <td>38 VA</td> </tr> <tr> <td>AC240 V</td> <td>35 VA</td> <td>55 VA</td> </tr> <tr> <td rowspan="2">2</td> <td rowspan="2">When the screen saver is operating</td> <td>AC100 V</td> <td>19 VA</td> <td>33 VA</td> </tr> <tr> <td>AC240 V</td> <td>27 VA</td> <td>49 VA</td> </tr> </tbody> </table>	No	Condition	Normal	During recharging battery	1	When the LCD is on	AC100 V	24 VA	38 VA	AC240 V	35 VA	55 VA	2	When the screen saver is operating	AC100 V	19 VA	33 VA	AC240 V	27 VA	49 VA
	No	Condition	Normal	During recharging battery																	
	1	When the LCD is on	AC100 V	24 VA	38 VA																
			AC240 V	35 VA	55 VA																
	2	When the screen saver is operating	AC100 V	19 VA	33 VA																
AC240 V			27 VA	49 VA																	
DC current consumption * Normal condition: LCD brightness is set to MAX.																					
<table border="1"> <thead> <tr> <th>No</th> <th>Condition</th> <th>Normal</th> <th>During recharging battery</th> </tr> </thead> <tbody> <tr> <td>1</td> <td rowspan="2">+24 V</td> <td>When the LCD is on</td> <td>0.36 A</td> <td>0.65 A</td> </tr> <tr> <td>2</td> <td>When the screen saver is operating</td> <td>0.27 A</td> <td>0.56 A</td> </tr> </tbody> </table>	No	Condition	Normal	During recharging battery	1	+24 V	When the LCD is on	0.36 A	0.65 A	2	When the screen saver is operating	0.27 A	0.56 A								
No	Condition	Normal	During recharging battery																		
1	+24 V	When the LCD is on	0.36 A	0.65 A																	
2		When the screen saver is operating	0.27 A	0.56 A																	
Display	7-inch TFT color LCD display (WVGA800 × 480 dots)																				
Display language	Japanese, English, French, German, Chinese, Korean, Russian, Spanish																				
External dimensions (approximate)	GL840-M (with standard terminal): 240 x 158 x 52.5 mm GL840-WV (Withstand High Voltage high-precision terminal): 240 x 166 x 52.5 mm																				
Weight (approximate)	GL840-M (with standard terminal): 1010g, GL840-WV (Withstand High Voltage high-precision terminal): 1050 g * AC adapter and battery are not included.																				
Vibration- tested conditions	Equivalent to automobile parts Type 1 category A classification																				

External Input/Output Functions

Item	Description
Input specifications (pulse/logic, trigger/ External sampling)	Maximum input voltage : 0 to +24V (single-ended ground input)
	Input threshold voltage : approximate +2.5 V
	Hysteresis : approximate 0.5 V (+2.5 V to +3 V)
Alarm output specifications	Output format : Open collector output (5 V, 10 kΩ pull-up resistance) * Refer to the User's Manual in the supplied CD-ROM for more information.

Common specification of the terminal in the input section

* The following specifications are common to GL840-M and GL840-WV.

Item	Description	
Number of input channels	M3 screw type, 20 channels (maximum 200 channels with extension unit)	
Method	Photo MOS relay scanning system, all channels isolated, balanced input	
Measurement accuracy	Voltage	20/50/100/200/500 mV, 1/2/5/10/20/50/100 V, 1-5 V F.S.
	Temperature	Thermocouple : K, J, E, T, R, S, B, N, W (WRe5-26)
		Resistance temperature detector : Pt100, JPt100, Pt1000 (IEC751)
		Measurement accuracy : 100°C, 500°C, 2000°C
Humidity	0 to 100% (voltage 0 V to 1 V scaling conversion)	
A/D converter	16-bit Delta-Sigma A/D converter (Effective resolution: approx. 1/40,000 of \pm range)	
Temperature coefficient	Gain : 0.01% of F.S./°C * Occurs when sampling speed is 10 ms/20 ms or 50 ms. Zero : 0.02% of F.S./°C	
Common mode rejection ratio	At least 90 dB (50/60 Hz; signal source 300 Ω or less)	
Noise	At least 48 dB (with +/- terminals shorted)	

Specification of input section (GL840-M with standard terminal)

Item	Description																																																																																										
Measurement accuracy *1 (23°C \pm 5°C) • When 30 minutes or more have elapsed after power was switched on • Sampling 1 s/20 ch • Filter ON (10) • GND connected	● Voltage : \pm0.1% of F.S. ● Thermocouple *1: Thermocouple diameters T, K: 0.32 ϕ , others: 0.65 ϕ																																																																																										
	<table border="1"> <thead> <tr> <th>Type</th> <th>Measurement Temperature Rang</th> <th>Measurement Accuracy</th> </tr> </thead> <tbody> <tr> <td rowspan="4">R/S</td> <td>0\leqTS\leq100°C</td> <td>\pm5.2°C</td> </tr> <tr> <td>100<TS\leq300°C</td> <td>\pm3.0°C</td> </tr> <tr> <td>R: 300<TS\leq1600°C</td> <td>\pm (0.05% of rdg +2.0°C)</td> </tr> <tr> <td>S: 300<TS\leq1760°C</td> <td>\pm (0.05% of rdg +2.0°C)</td> </tr> <tr> <td rowspan="2">B</td> <td>400\leqTS\leq600°C</td> <td>\pm3.5°C</td> </tr> <tr> <td>600<TS\leq1820°C</td> <td>\pm (0.05% of rdg +2.0°C)</td> </tr> <tr> <td rowspan="2">K</td> <td>-200\leqTS\leq-100°C</td> <td>\pm (0.05% of rdg +2.0°C)</td> </tr> <tr> <td>-100<TS\leq1370°C</td> <td>\pm (0.05% of rdg +1.0°C)</td> </tr> <tr> <td rowspan="2">E</td> <td>-200\leqTS\leq-100°C</td> <td>\pm (0.05% of rdg +2.0°C)</td> </tr> <tr> <td>-100<TS\leq800°C</td> <td>\pm (0.05% of rdg +1.0°C)</td> </tr> <tr> <td rowspan="2">T</td> <td>-200\leqTS\leq-100°C</td> <td>\pm (0.1% of rdg +1.5°C)</td> </tr> <tr> <td>-100<TS\leq400°C</td> <td>\pm (0.1% of rdg +0.5°C)</td> </tr> <tr> <td rowspan="2">J</td> <td>-200\leqTS\leq-100°C</td> <td>\pm2.7°C</td> </tr> <tr> <td>-100<TS\leq100°C</td> <td>\pm1.7°C</td> </tr> <tr> <td rowspan="2">N</td> <td>100<TS\leq1100°C</td> <td>\pm (0.05% of rdg +1.0°C)</td> </tr> <tr> <td>-200\leqTS\leq0°C</td> <td>\pm (0.1% of rdg +2.0°C)</td> </tr> <tr> <td rowspan="2">W</td> <td>0\leqTS\leq1300°C</td> <td>\pm (0.1% of rdg +1.0°C)</td> </tr> <tr> <td>0\leqTS\leq2000°C</td> <td>\pm (0.1% of rdg +1.5°C)</td> </tr> <tr> <td colspan="2">Reference contact compensation accuracy</td> <td>\pm0.5°C</td> </tr> <tr> <td colspan="3"> ● Resistance temperature detector * 3-wire system </td> </tr> <tr> <td colspan="4"> <table border="1"> <thead> <tr> <th>Type</th> <th>Measurement Temperature Range</th> <th>Applied current</th> <th>Accuracy</th> </tr> </thead> <tbody> <tr> <td>Pt100</td> <td>-200 to 850°C</td> <td>1mA</td> <td>\pm1.0°C</td> </tr> <tr> <td>JPt100</td> <td>-200 to 500°C</td> <td>1mA</td> <td>\pm0.8°C</td> </tr> <tr> <td>Pt1000</td> <td>-200 to 500°C</td> <td>0.3mA</td> <td>\pm0.8°C</td> </tr> </tbody> </table> </td> </tr> <tr> <td rowspan="3">Maximum input voltage</td> <td colspan="3">Between +/- terminals : 20mV to 2Vrange (60Vp-p) 5V to 100V range (110Vp-p)</td> </tr> <tr> <td colspan="3">Between input terminal/input terminal : 60Vp-p</td> </tr> <tr> <td colspan="3">Between input terminal/GND : 60Vp-p</td> </tr> <tr> <td rowspan="2">Withstand voltage</td> <td colspan="3">Between input terminal/input terminal : 1 minute at 350Vp-p</td> </tr> <tr> <td colspan="3">Between input terminal/GND : 1 minute at 350Vp-p</td> </tr> </tbody> </table>	Type	Measurement Temperature Rang	Measurement Accuracy	R/S	0 \leq TS \leq 100°C	\pm 5.2°C	100<TS \leq 300°C	\pm 3.0°C	R: 300<TS \leq 1600°C	\pm (0.05% of rdg +2.0°C)	S: 300<TS \leq 1760°C	\pm (0.05% of rdg +2.0°C)	B	400 \leq TS \leq 600°C	\pm 3.5°C	600<TS \leq 1820°C	\pm (0.05% of rdg +2.0°C)	K	-200 \leq TS \leq -100°C	\pm (0.05% of rdg +2.0°C)	-100<TS \leq 1370°C	\pm (0.05% of rdg +1.0°C)	E	-200 \leq TS \leq -100°C	\pm (0.05% of rdg +2.0°C)	-100<TS \leq 800°C	\pm (0.05% of rdg +1.0°C)	T	-200 \leq TS \leq -100°C	\pm (0.1% of rdg +1.5°C)	-100<TS \leq 400°C	\pm (0.1% of rdg +0.5°C)	J	-200 \leq TS \leq -100°C	\pm 2.7°C	-100<TS \leq 100°C	\pm 1.7°C	N	100<TS \leq 1100°C	\pm (0.05% of rdg +1.0°C)	-200 \leq TS \leq 0°C	\pm (0.1% of rdg +2.0°C)	W	0 \leq TS \leq 1300°C	\pm (0.1% of rdg +1.0°C)	0 \leq TS \leq 2000°C	\pm (0.1% of rdg +1.5°C)	Reference contact compensation accuracy		\pm 0.5°C	● Resistance temperature detector * 3-wire system			<table border="1"> <thead> <tr> <th>Type</th> <th>Measurement Temperature Range</th> <th>Applied current</th> <th>Accuracy</th> </tr> </thead> <tbody> <tr> <td>Pt100</td> <td>-200 to 850°C</td> <td>1mA</td> <td>\pm1.0°C</td> </tr> <tr> <td>JPt100</td> <td>-200 to 500°C</td> <td>1mA</td> <td>\pm0.8°C</td> </tr> <tr> <td>Pt1000</td> <td>-200 to 500°C</td> <td>0.3mA</td> <td>\pm0.8°C</td> </tr> </tbody> </table>				Type	Measurement Temperature Range	Applied current	Accuracy	Pt100	-200 to 850°C	1mA	\pm 1.0°C	JPt100	-200 to 500°C	1mA	\pm 0.8°C	Pt1000	-200 to 500°C	0.3mA	\pm 0.8°C	Maximum input voltage	Between +/- terminals : 20mV to 2Vrange (60Vp-p) 5V to 100V range (110Vp-p)			Between input terminal/input terminal : 60Vp-p			Between input terminal/GND : 60Vp-p			Withstand voltage	Between input terminal/input terminal : 1 minute at 350Vp-p			Between input terminal/GND : 1 minute at 350Vp-p		
	Type	Measurement Temperature Rang	Measurement Accuracy																																																																																								
	R/S	0 \leq TS \leq 100°C	\pm 5.2°C																																																																																								
		100<TS \leq 300°C	\pm 3.0°C																																																																																								
		R: 300<TS \leq 1600°C	\pm (0.05% of rdg +2.0°C)																																																																																								
		S: 300<TS \leq 1760°C	\pm (0.05% of rdg +2.0°C)																																																																																								
	B	400 \leq TS \leq 600°C	\pm 3.5°C																																																																																								
		600<TS \leq 1820°C	\pm (0.05% of rdg +2.0°C)																																																																																								
	K	-200 \leq TS \leq -100°C	\pm (0.05% of rdg +2.0°C)																																																																																								
		-100<TS \leq 1370°C	\pm (0.05% of rdg +1.0°C)																																																																																								
	E	-200 \leq TS \leq -100°C	\pm (0.05% of rdg +2.0°C)																																																																																								
		-100<TS \leq 800°C	\pm (0.05% of rdg +1.0°C)																																																																																								
	T	-200 \leq TS \leq -100°C	\pm (0.1% of rdg +1.5°C)																																																																																								
		-100<TS \leq 400°C	\pm (0.1% of rdg +0.5°C)																																																																																								
J	-200 \leq TS \leq -100°C	\pm 2.7°C																																																																																									
	-100<TS \leq 100°C	\pm 1.7°C																																																																																									
N	100<TS \leq 1100°C	\pm (0.05% of rdg +1.0°C)																																																																																									
	-200 \leq TS \leq 0°C	\pm (0.1% of rdg +2.0°C)																																																																																									
W	0 \leq TS \leq 1300°C	\pm (0.1% of rdg +1.0°C)																																																																																									
	0 \leq TS \leq 2000°C	\pm (0.1% of rdg +1.5°C)																																																																																									
Reference contact compensation accuracy		\pm 0.5°C																																																																																									
● Resistance temperature detector * 3-wire system																																																																																											
<table border="1"> <thead> <tr> <th>Type</th> <th>Measurement Temperature Range</th> <th>Applied current</th> <th>Accuracy</th> </tr> </thead> <tbody> <tr> <td>Pt100</td> <td>-200 to 850°C</td> <td>1mA</td> <td>\pm1.0°C</td> </tr> <tr> <td>JPt100</td> <td>-200 to 500°C</td> <td>1mA</td> <td>\pm0.8°C</td> </tr> <tr> <td>Pt1000</td> <td>-200 to 500°C</td> <td>0.3mA</td> <td>\pm0.8°C</td> </tr> </tbody> </table>				Type	Measurement Temperature Range	Applied current	Accuracy	Pt100	-200 to 850°C	1mA	\pm 1.0°C	JPt100	-200 to 500°C	1mA	\pm 0.8°C	Pt1000	-200 to 500°C	0.3mA	\pm 0.8°C																																																																								
Type	Measurement Temperature Range	Applied current	Accuracy																																																																																								
Pt100	-200 to 850°C	1mA	\pm 1.0°C																																																																																								
JPt100	-200 to 500°C	1mA	\pm 0.8°C																																																																																								
Pt1000	-200 to 500°C	0.3mA	\pm 0.8°C																																																																																								
Maximum input voltage	Between +/- terminals : 20mV to 2Vrange (60Vp-p) 5V to 100V range (110Vp-p)																																																																																										
	Between input terminal/input terminal : 60Vp-p																																																																																										
	Between input terminal/GND : 60Vp-p																																																																																										
Withstand voltage	Between input terminal/input terminal : 1 minute at 350Vp-p																																																																																										
	Between input terminal/GND : 1 minute at 350Vp-p																																																																																										

Specification of input section (GL840-WV Withstand High Voltage high-precision terminal)

Item	Description																																																																																																			
Measurement accuracy *1 (23°C ±5°C) • When 30 minutes or more have elapsed after power was switched on • Sampling 1 s/10 ch • Filter ON (10) • GND connected	● Voltage : ± (0.05% of F.S. +10 μV) ● Thermocouple *1: Thermocouple diameters T, K: 0.32 φ, others: 0.65 φ																																																																																																			
	<table border="1"> <thead> <tr> <th>Type</th> <th>Measurement Temperature Rang</th> <th>Measurement Accuracy</th> </tr> </thead> <tbody> <tr> <td rowspan="4">R/S</td> <td>0≤TS≤100°C</td> <td>±4.5°C</td> </tr> <tr> <td>100<TS≤300°C</td> <td>±3.0°C</td> </tr> <tr> <td>R: 300<TS≤1600°C</td> <td>±2.2°C</td> </tr> <tr> <td>S: 300<TS≤1760°C</td> <td>±2.2°C</td> </tr> <tr> <td rowspan="2">B</td> <td>400≤TS≤600°C</td> <td>±3.5°C</td> </tr> <tr> <td>600<TS≤1820°C</td> <td>±2.5°C</td> </tr> <tr> <td rowspan="2">K</td> <td>-200≤TS≤-100°C</td> <td>±1.5°C</td> </tr> <tr> <td>-100<TS≤1370°C</td> <td>±0.8°C</td> </tr> <tr> <td rowspan="2">E</td> <td>-200≤TS≤-100°C</td> <td>±1.0°C</td> </tr> <tr> <td>-100<TS≤800°C</td> <td>±0.8°C</td> </tr> <tr> <td rowspan="2">T</td> <td>-200≤TS≤-100°C</td> <td>±1.5°C</td> </tr> <tr> <td>-100<TS≤400°C</td> <td>±0.6°C</td> </tr> <tr> <td rowspan="3">J</td> <td>-200≤TS≤-100°C</td> <td>±1.0°C</td> </tr> <tr> <td>-100<TS≤100°C</td> <td>±0.8°C</td> </tr> <tr> <td>100<TS≤1100°C</td> <td>±0.6°C</td> </tr> <tr> <td rowspan="2">N</td> <td>-200≤TS<0°C</td> <td>±2.2°C</td> </tr> <tr> <td>0≤TS≤1300°C</td> <td>±1.0°C</td> </tr> <tr> <td>W</td> <td>0≤TS≤2000°C</td> <td>±1.8°C</td> </tr> <tr> <td colspan="2">Reference contact compensation accuracy</td> <td>±0.3°C</td> </tr> <tr> <td colspan="3"> ● Resistance temperature detector * 3-wire system </td> </tr> <tr> <td></td> <td> <table border="1"> <thead> <tr> <th>Type</th> <th>Measurement Temperature Range</th> <th>Applied current</th> <th>Accuracy</th> </tr> </thead> <tbody> <tr> <td rowspan="3">Pt100</td> <td>-200≤TS≤100°C</td> <td rowspan="3">1mA</td> <td>±0.6°C</td> </tr> <tr> <td>100<TS≤500°C</td> <td>±0.8°C</td> </tr> <tr> <td>500<TS≤850°C</td> <td>±1.0°C</td> </tr> <tr> <td rowspan="2">JPt100</td> <td>-200≤TS≤100°C</td> <td rowspan="2">1mA</td> <td>±0.6°C</td> </tr> <tr> <td>100<TS≤500°C</td> <td>±0.8°C</td> </tr> <tr> <td rowspan="2">Pt1000</td> <td>-200≤TS≤100°C</td> <td rowspan="2">0.3mA</td> <td>±0.6°C</td> </tr> <tr> <td>100<TS≤500°C</td> <td>±0.8°C</td> </tr> </tbody> </table> </td> </tr> <tr> <td rowspan="3">Maximum input voltage</td> <td colspan="3">Between +/- terminals : 20mV to 2Vrange (60Vp-p)</td> </tr> <tr> <td colspan="3">5V to 100V range (110Vp-p)</td> </tr> <tr> <td colspan="3">Between input terminal/input terminal : 600Vp-p</td> </tr> <tr> <td rowspan="3">Withstand voltage</td> <td colspan="3">Between input terminal/GND : 300Vp-p</td> </tr> <tr> <td colspan="3">Between input terminal/input terminal : 1 minute at 600Vp-p</td> </tr> <tr> <td colspan="3">Between input terminal/GND : 1 minute at 2300Vp-p</td> </tr> </tbody> </table>	Type	Measurement Temperature Rang	Measurement Accuracy	R/S	0≤TS≤100°C	±4.5°C	100<TS≤300°C	±3.0°C	R: 300<TS≤1600°C	±2.2°C	S: 300<TS≤1760°C	±2.2°C	B	400≤TS≤600°C	±3.5°C	600<TS≤1820°C	±2.5°C	K	-200≤TS≤-100°C	±1.5°C	-100<TS≤1370°C	±0.8°C	E	-200≤TS≤-100°C	±1.0°C	-100<TS≤800°C	±0.8°C	T	-200≤TS≤-100°C	±1.5°C	-100<TS≤400°C	±0.6°C	J	-200≤TS≤-100°C	±1.0°C	-100<TS≤100°C	±0.8°C	100<TS≤1100°C	±0.6°C	N	-200≤TS<0°C	±2.2°C	0≤TS≤1300°C	±1.0°C	W	0≤TS≤2000°C	±1.8°C	Reference contact compensation accuracy		±0.3°C	● Resistance temperature detector * 3-wire system				<table border="1"> <thead> <tr> <th>Type</th> <th>Measurement Temperature Range</th> <th>Applied current</th> <th>Accuracy</th> </tr> </thead> <tbody> <tr> <td rowspan="3">Pt100</td> <td>-200≤TS≤100°C</td> <td rowspan="3">1mA</td> <td>±0.6°C</td> </tr> <tr> <td>100<TS≤500°C</td> <td>±0.8°C</td> </tr> <tr> <td>500<TS≤850°C</td> <td>±1.0°C</td> </tr> <tr> <td rowspan="2">JPt100</td> <td>-200≤TS≤100°C</td> <td rowspan="2">1mA</td> <td>±0.6°C</td> </tr> <tr> <td>100<TS≤500°C</td> <td>±0.8°C</td> </tr> <tr> <td rowspan="2">Pt1000</td> <td>-200≤TS≤100°C</td> <td rowspan="2">0.3mA</td> <td>±0.6°C</td> </tr> <tr> <td>100<TS≤500°C</td> <td>±0.8°C</td> </tr> </tbody> </table>	Type	Measurement Temperature Range	Applied current	Accuracy	Pt100	-200≤TS≤100°C	1mA	±0.6°C	100<TS≤500°C	±0.8°C	500<TS≤850°C	±1.0°C	JPt100	-200≤TS≤100°C	1mA	±0.6°C	100<TS≤500°C	±0.8°C	Pt1000	-200≤TS≤100°C	0.3mA	±0.6°C	100<TS≤500°C	±0.8°C	Maximum input voltage	Between +/- terminals : 20mV to 2Vrange (60Vp-p)			5V to 100V range (110Vp-p)			Between input terminal/input terminal : 600Vp-p			Withstand voltage	Between input terminal/GND : 300Vp-p			Between input terminal/input terminal : 1 minute at 600Vp-p			Between input terminal/GND : 1 minute at 2300Vp-p		
	Type	Measurement Temperature Rang	Measurement Accuracy																																																																																																	
	R/S	0≤TS≤100°C	±4.5°C																																																																																																	
		100<TS≤300°C	±3.0°C																																																																																																	
		R: 300<TS≤1600°C	±2.2°C																																																																																																	
		S: 300<TS≤1760°C	±2.2°C																																																																																																	
	B	400≤TS≤600°C	±3.5°C																																																																																																	
		600<TS≤1820°C	±2.5°C																																																																																																	
	K	-200≤TS≤-100°C	±1.5°C																																																																																																	
		-100<TS≤1370°C	±0.8°C																																																																																																	
	E	-200≤TS≤-100°C	±1.0°C																																																																																																	
		-100<TS≤800°C	±0.8°C																																																																																																	
	T	-200≤TS≤-100°C	±1.5°C																																																																																																	
		-100<TS≤400°C	±0.6°C																																																																																																	
	J	-200≤TS≤-100°C	±1.0°C																																																																																																	
		-100<TS≤100°C	±0.8°C																																																																																																	
		100<TS≤1100°C	±0.6°C																																																																																																	
	N	-200≤TS<0°C	±2.2°C																																																																																																	
		0≤TS≤1300°C	±1.0°C																																																																																																	
W	0≤TS≤2000°C	±1.8°C																																																																																																		
Reference contact compensation accuracy		±0.3°C																																																																																																		
● Resistance temperature detector * 3-wire system																																																																																																				
	<table border="1"> <thead> <tr> <th>Type</th> <th>Measurement Temperature Range</th> <th>Applied current</th> <th>Accuracy</th> </tr> </thead> <tbody> <tr> <td rowspan="3">Pt100</td> <td>-200≤TS≤100°C</td> <td rowspan="3">1mA</td> <td>±0.6°C</td> </tr> <tr> <td>100<TS≤500°C</td> <td>±0.8°C</td> </tr> <tr> <td>500<TS≤850°C</td> <td>±1.0°C</td> </tr> <tr> <td rowspan="2">JPt100</td> <td>-200≤TS≤100°C</td> <td rowspan="2">1mA</td> <td>±0.6°C</td> </tr> <tr> <td>100<TS≤500°C</td> <td>±0.8°C</td> </tr> <tr> <td rowspan="2">Pt1000</td> <td>-200≤TS≤100°C</td> <td rowspan="2">0.3mA</td> <td>±0.6°C</td> </tr> <tr> <td>100<TS≤500°C</td> <td>±0.8°C</td> </tr> </tbody> </table>	Type	Measurement Temperature Range	Applied current	Accuracy	Pt100	-200≤TS≤100°C	1mA	±0.6°C	100<TS≤500°C	±0.8°C	500<TS≤850°C	±1.0°C	JPt100	-200≤TS≤100°C	1mA	±0.6°C	100<TS≤500°C	±0.8°C	Pt1000	-200≤TS≤100°C	0.3mA	±0.6°C	100<TS≤500°C	±0.8°C																																																																											
Type	Measurement Temperature Range	Applied current	Accuracy																																																																																																	
Pt100	-200≤TS≤100°C	1mA	±0.6°C																																																																																																	
	100<TS≤500°C		±0.8°C																																																																																																	
	500<TS≤850°C		±1.0°C																																																																																																	
JPt100	-200≤TS≤100°C	1mA	±0.6°C																																																																																																	
	100<TS≤500°C		±0.8°C																																																																																																	
Pt1000	-200≤TS≤100°C	0.3mA	±0.6°C																																																																																																	
	100<TS≤500°C		±0.8°C																																																																																																	
Maximum input voltage	Between +/- terminals : 20mV to 2Vrange (60Vp-p)																																																																																																			
	5V to 100V range (110Vp-p)																																																																																																			
	Between input terminal/input terminal : 600Vp-p																																																																																																			
Withstand voltage	Between input terminal/GND : 300Vp-p																																																																																																			
	Between input terminal/input terminal : 1 minute at 600Vp-p																																																																																																			
	Between input terminal/GND : 1 minute at 2300Vp-p																																																																																																			

Installation Guide

For the install procedure of the GL840 application software (USB driver / GL100_240_840-APS), refer to the "Application Software Manual" included in the attached CD-ROM.

GRAPHTEC

Specifications are subject to change without notice.

GL840 Quick Start Guide
(GL840-UM-850)

May 1, 2015
1st edition-01

Publisher GRAPHTEC CORPORATION