

midi LOGGER

GL800 Quick Start Guide

GL800-UM-851

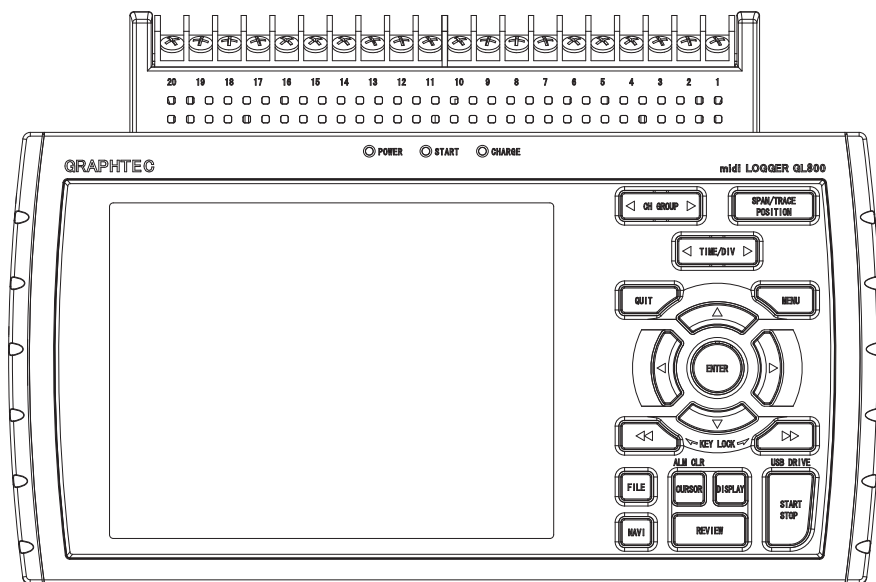

Checking the Outer Casing

After unpacking, check the GL800's outer casing before use to make sure that there are no surface scratches or other flaws such as stains or dirt.

Checking the Accessories

- | | | | | | |
|--|---|---|---------------------------------|---|---|
| <input type="checkbox"/> Quick Start Guide | : | 1 | <input type="checkbox"/> CD-ROM | : | 1 |
| <input type="checkbox"/> AC cable/AC adapter | : | 1 | | | |

Setting and Checking the AC Line Frequency

Set the AC line frequency in the "OTHR" menu.
This setting (50 or 60 Hz) affects the device's noise elimination capability.

Don't forget to check the setting

GL800 Contents

Part Names.....	2
Connection Procedures.....	3
Precautions to Observe When Performing Measurement.....	4
Descriptions of the Control Panel Keys.....	5
Descriptions of the Menu Screens.....	8
Measurement Procedure.....	9
1.Preparations : How to Make the Preparations Required for Data Capture.....	9
2.Setup : How to Make the Settings for Temperature Measurement.....	10
3.Data Capture : How to Measure the Temperature.....	13
4.Data Replay : How to Replay Captured Data.....	14
Convenient Functions.....	15
Trigger Functions to Control Data Capture Start/Stop Operations.....	15
Span, Position and Trace Functions to Adjust the Waveform Display.....	17
Specifications.....	18
Standard Specifications.....	18
External Input/Output Functions.....	18
Input Unit Specifications.....	19
Installation Guide.....	20

GL800 Part Names

Top Panel

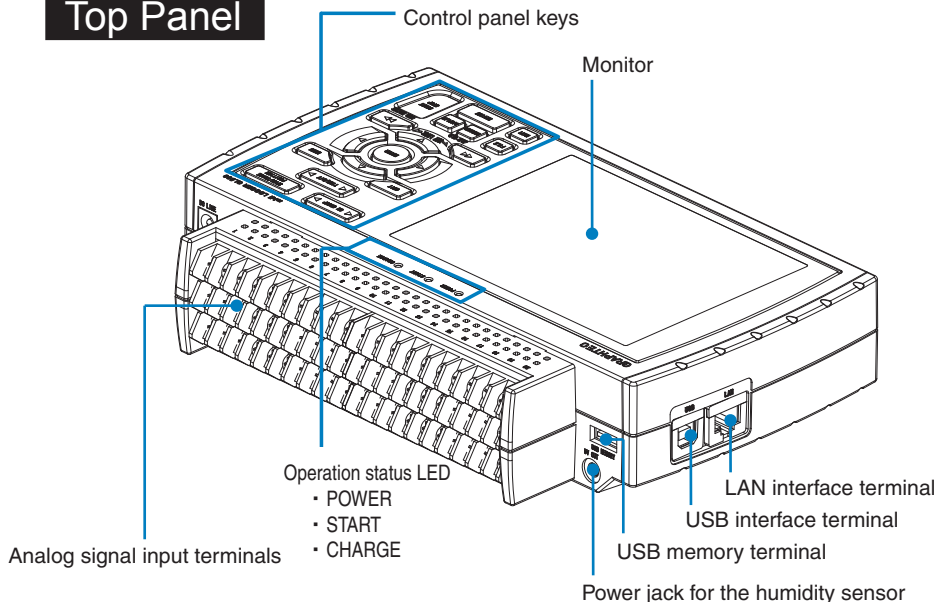

Bottom Panel

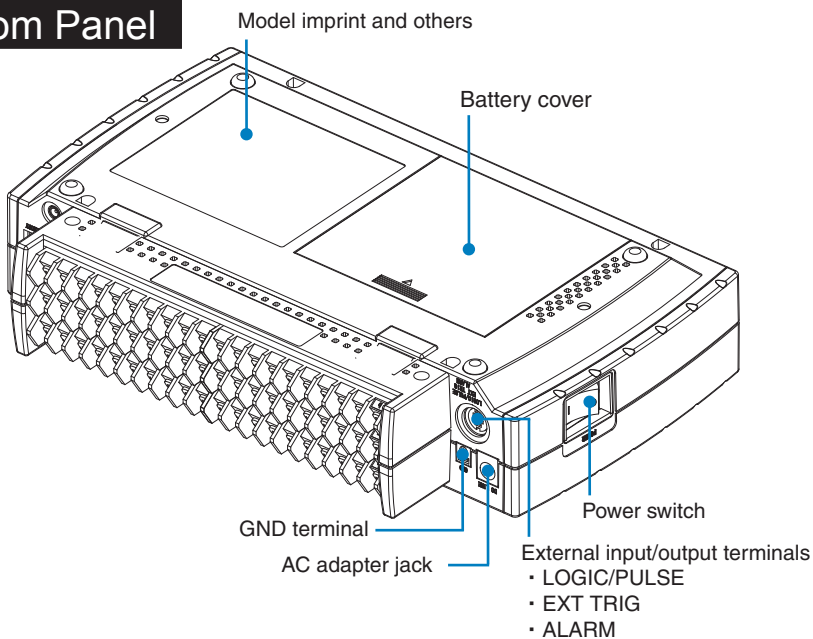

GL800 Connection Procedures

Connecting the AC Adapter

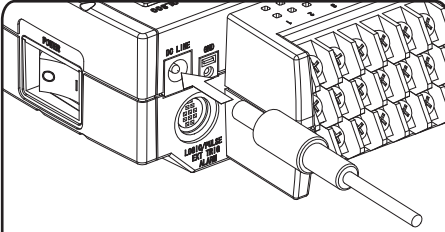

Connect the output side of the AC adapter to the connector indicated as "DC LINE" on the GL800.

Connecting the Grounding Cable

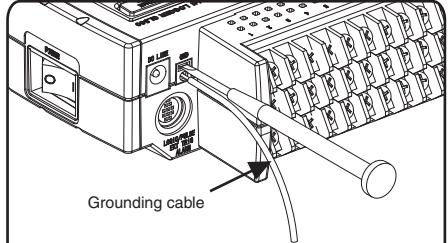

Use a flathead screwdriver to push the button above the ground terminal while connecting the grounding cable to the GL800. Connect the other end of the cable to ground.

Making Connections to the Analog Input Terminals

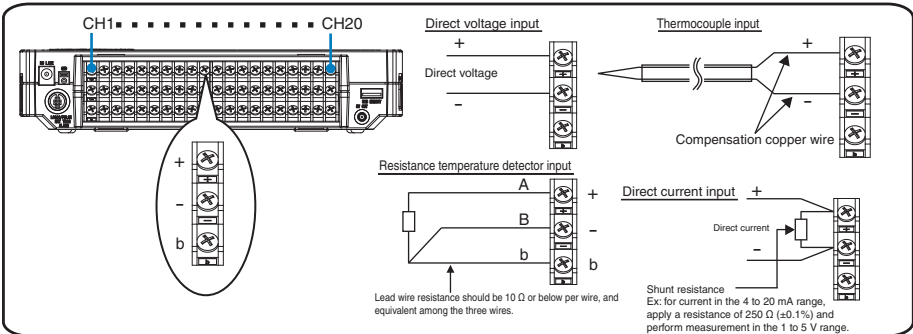

Making Connections to the External Input/Output Terminals (Using B-513)

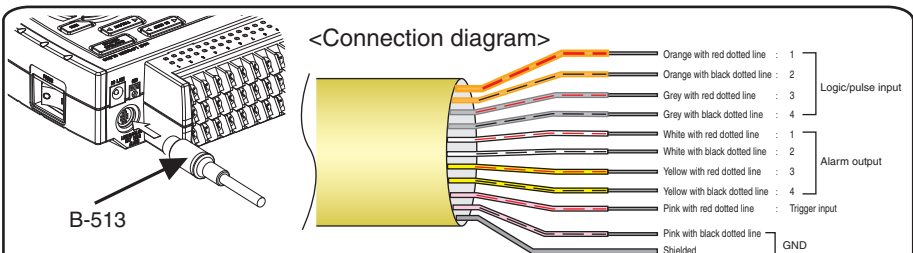

*B-513 (sold separately) cable is required for external input/output.
(For logic/pulse input, alarm output, trigger input)

Precautions to Observe When Performing Measurement

- **Avoid electrical shock and short circuit accidents**
 - Do not apply voltage of AC33 Vrms or 60 VDC or above between the analog input section and main unit (GND terminal), or to between each analog channel.
 - Do not apply voltage of AC33 Vrms or 60 VDC or above to analog input section (between + and - terminals).
 - Do not apply radio-frequency signals.
- **Warming-up**
The GL800 should be allowed to warm up with the power turned on for approximately 30 minutes to achieve operation according to the specified performance.

• Unused channels

Capacitors have been incorporated into the analog input circuit to increase the noise elimination capability.

Therefore, if input terminal is open, or signals are not input to the terminal, measured results may be influenced by signals from other channels. In such a case, set input setting to “Off” or short circuit the + and – terminals.

If signals are input correctly, measured results are not influenced by other channels.

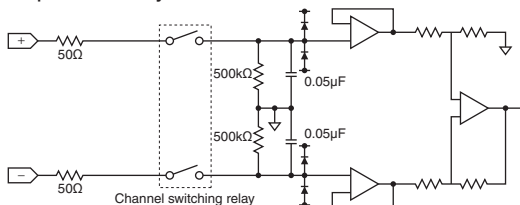

• Noise countermeasures

If measured values fluctuate due to extraneous noise, conduct the following countermeasures.

(Results may differ according to noise type.)

Ex 1: Connect the GL800's GND to ground.

Ex 2: Connect GL800's GND to measurement object's GND.

Ex 3: Operate GL800 with batteries (B-517).

Ex 4: In the AMP settings menu, set filter to any setting other than “OFF”.

Ex 5: Set the sampling interval which enables GL800's digital filter (see table below).

Number of Measuring Channels*	Sampling Interval which enables Digital Filter
10 channels or less	500 msec or above
11 to 20 channels	1 sec or above
21 to 50 channels	2 sec or above
51 to 100 channels	5 sec or above
101 to 200 channels	10 sec or above

*"Number of Measuring Channels" is the number of channels in which input settings are NOT set to “OFF”.

GL800 Descriptions of the Control Panel Keys

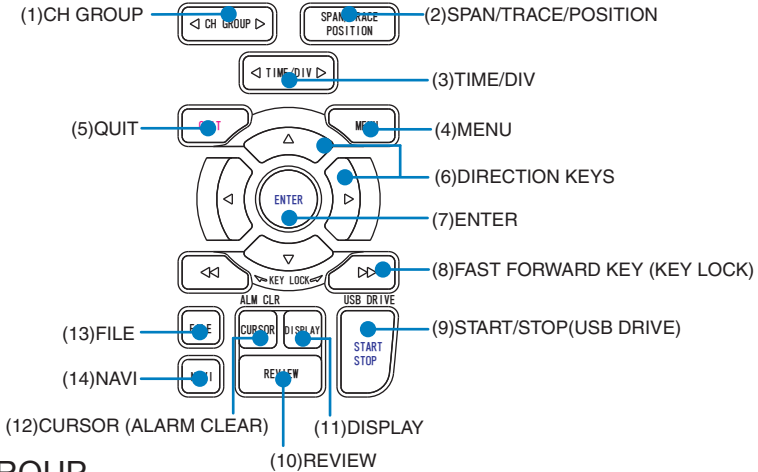

1 CH GROUP

Press this key to switch to the next group consisting of 10 channels.
 Press the ◀ side to switch to the group consisting of the next 10 channels with a smaller number.
 Press the ▶ side to switch to the group consisting of the next 10 channels with a larger number.

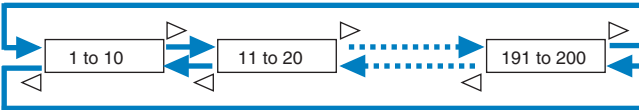

2 SPAN/TRACE/POSITION

This key enables SPAN, POSITION, and TRACE settings to be made independently for each channel. Each time this key is pressed, the mode displayed in the waveform operation display area changes in the sequence shown below. Use the ▲ and ▼ keys to select the channel, and the ◀ and ▶ keys to change the setting values.

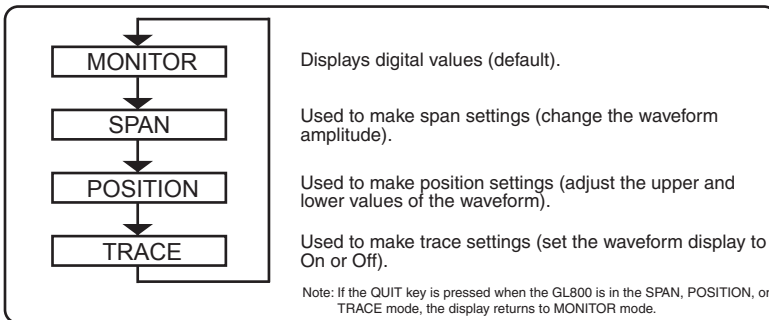

3 TIME/DIV

Press the TIME/DIV key to change the time axis display range on the waveform screen.

4 MENU

Press the MENU key to open a setup menu. Each time this key is pressed, the setup screen tabs change in the sequence shown below.

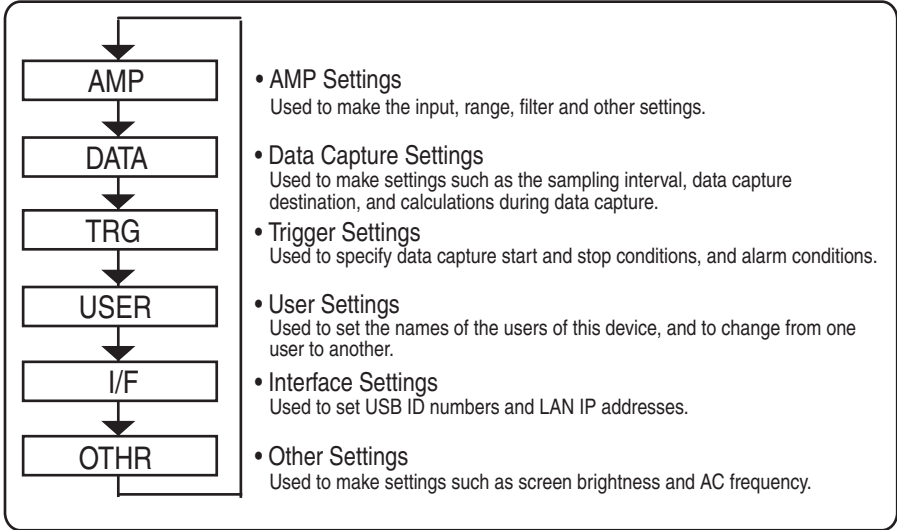

5 QUIT (LOCAL)

Press the QUIT key to cancel the settings and return them to their default status. If the device is in the Remote (Key Lock) status, namely the external operating status via the interface, press this key to return the device to the normal operating status (Local).

6 ▽△◀▶ keys (DIRECTION KEYS)

These keys are used to select menu setup items, to make span settings in the digital display area, to move the cursors during a data replay operation, and so forth.

7 ENTER

Press the ENTER key to enter the settings made in the setup menus, and to confirm your settings.

8 ◀◀ ▶▶ keys (KEY LOCK)

These keys are used to move the cursor at high speed during a data replay operation, and to change the operation mode in the file settings box. Hold down both keys simultaneously for at least two seconds to enable key lock status. To cancel key lock status, press them again for at least two seconds. The key lock status can be confirmed by the status of the key lock lamp on the monitor.

9 START/STOP (USB DRIVE) key

Press the START/STOP key to perform a data capture start operation while the GL800 is in the Free Running status, and a data capture stop operation when data capture has ended. If this key is held down while the power to the GL800 is turned on, the GL800 goes into USB Drive Mode.

10 REVIEW key

Press the REVIEW key to perform a data capture start operation while the GL800 is in the Free Running status, and a data capture stop operation when data capture has ended. If this key is held down while the power to the GL800 is turned on, the GL800 goes into USB Drive Mode.

Note: A data replay operation will not be performed if data has not been captured.

11 DISPLAY key

Press the DISPLAY key

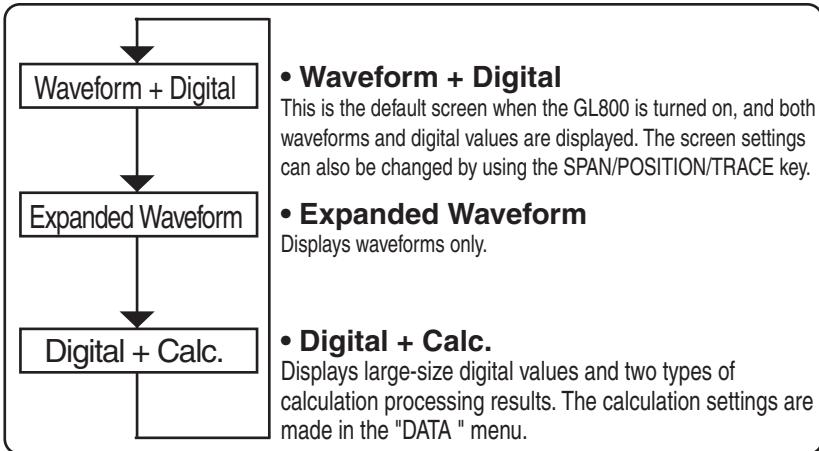

12 CURSOR (ALM CLR) key

Press the CURSOR key to switch between the A and B cursors during a data replay operation. If the Alarm setting has been specified as "Alarm Hold", press this key to clear the alarm. The alarm settings are made in the "TRIG" menu.

13 FILE key

Press the FILE key to save data to the GL800's internal memory and to a USB memory device.

14 NAVI key

Press the NAVI key to display operational descriptions during the Free Running status, and during data capture and data replay operations.

GL800 Descriptions of the Menu Screens

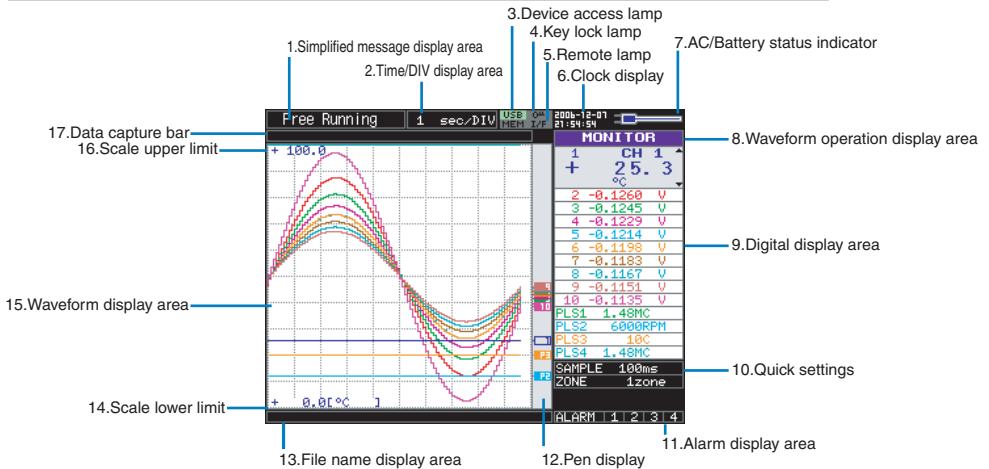

- 1.Simplified message display area : Displays the operating status.
- 2.Time/DIV display area : Displays the current time scale.
- 3.Device access lamp : Turns red when USB memory is accessed. When the GL800's internal memory is being accessed, the MEM lamp turns red.
- 4.Key lock lamp : Displays the key lock status. (Yellow = keys locked, white = not locked)
- 5.Remote lamp: : Displays the remote status. (Yellow = Remote status, white = Local status)
- 6.Clock display : Displays the current date and time.
- 7.AC/Battery status indicator : Displays the following icons to indicate the operating status of the AC power supply and the battery.

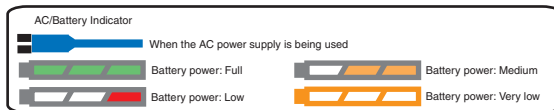

- 8.Waveform operation display area : Displays the mode selected by the SPAN/POSITION/TRACE key.
- 9.Digital display area : Displays the input values for each channel. The Δ and ∇ keys can be used to select the active channel (enlarged display). Moreover, the selected active channel is displayed at the very top of the waveform display.
- 10.Quick settings : Displays items that can be easily set. The Δ and ∇ keys can be used to make a Quick settings item active, and the \langle and \rangle keys to change the values.
- 11.Alarm display area : Displays the status of the alarm output terminal. (Red = alarm generated, white = alarm not generated)
- 12.Pen display : Displays the signal positions, trigger positions, and alarm ranges for each channel.

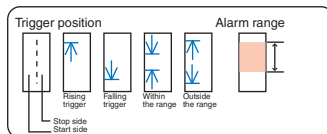

- 13.File name display area: : Displays the data capture file name during the data capture operation. During a data replay operation, the name of the data replay file is displayed.
- 14.Scale lower limit: : Displays the lower limit of the scale of the currently active channel.
- 15.Waveform display area: : The input signal waveforms are displayed here.
- 16.Scale upper limit: : Displays the upper limit of the scale of the currently active channel.
- 17.Data capture bar : During a data capture operation, this bar displays the remaining memory capacity of the device used for data capture. When data is being replayed, the display position information is displayed here.

GL800 Measurement Procedure

In this section we will provide a simple explanation of the data capture procedure: Preparations → Setup → Data Capture → Data Replay.
T thermocouples will be used here to perform temperature measurement.

- Purpose of data capture : To measure the temperature of the target objects
- Measurement points : 2 locations
- Sampling interval : 1 second
- Data save destination : USB memory device
- Important point : We want to check captured data even during a data capture operation.
- Items that must be supplied : T thermocouples, USB memory device

Note: If you do not have a USB memory device, capture data to the GL800's internal memory instead.

1. Preparations : How to Make the Preparations Required for Data Capture

1. Connect measurement object 1 to the CH 1 terminal.
2. Connect measurement object 2 to the CH 2 terminal.
3. Connect the AC power supply.
4. Insert the USB memory device.
5. Turn on the power supply.

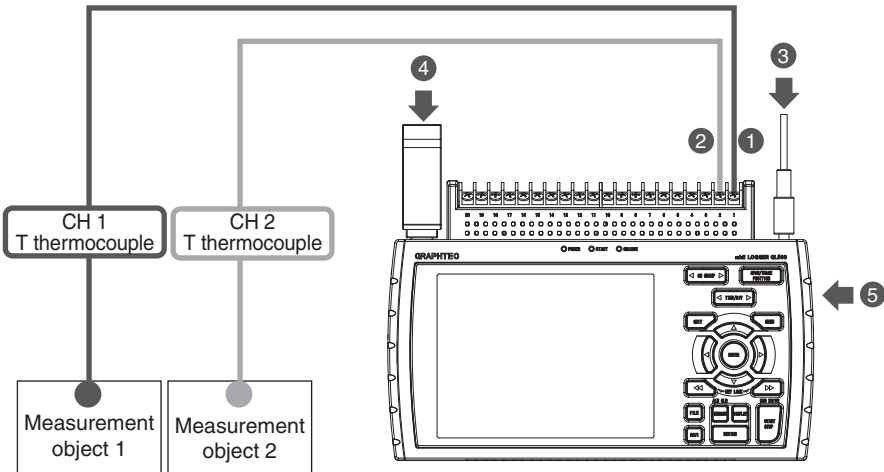

2. Setup : How to Make the Settings for Temperature Measurement

Make the settings required for data capture. Here we will make only those settings that are absolutely necessary. The other settings will be left as the default settings (the settings made prior to shipment from the factory)

Points to Remember Basic Setup Menu Operation

The keys used on the menu screens are the $\nabla/\Delta/\leftarrow/\rightarrow$ keys, the ENTER key, and the QUIT key. The current cursor position is displayed in blue. Use the $\nabla/\Delta/\leftarrow/\rightarrow$ keys to move the cursor. If you press the ENTER key at the cursor position, a selection menu or a box for inputting numeric values and so forth is displayed. If you press the QUIT key, the screen closes and the settings are canceled.

Examples of selection menu operations (AMP screen)

1. Use the $\nabla/\Delta/\leftarrow/\rightarrow$ keys to move the cursor to the Input parameter opposite CH 1 and then press the ENTER key.

AMP	DATA	TRIG	USER	I/F
Making analog and pulse				
· Display Logic/Pulse Da				
CH:	Input	Range		
ALL:	∇DC	50 V		
1:	∇DC	50 V		
2:	∇DC	50 V		
3:	∇DC	50 V		
4:	∇DC	50 V		
5:	∇DC	50 V		
6:	∇DC	50 V		
7:	∇DC	50 V		

2. A selection menu is displayed when the ENTER key is pressed. Use the Δ and ∇ keys to select "TEMP."

AMP	DATA	TRIG	USER	I/F
Making analog and pulse				
· Display Logic/Pulse Da				
CH:	Input	Range		
ALL:	∇DC	50 V		
1:	∇DC	50 V		
2:	Off	50 V		
3:	∇DC	50 V		
4:	∇TEMP	50 V		
5:	∇RH	50 V		
6:	∇DC	50 V		
7:	∇DC	50 V		

3. Press the ENTER key to confirm your selection.

AMP	DATA	TRIG	USER	I/F
Making analog and pulse				
· Display Logic/Pulse Da				
CH:	Input	Range		
ALL:	∇TEMP	TC-K		
1:	∇TEMP	TC-K		
2:	∇DC	50 V		
3:	∇DC	50 V		
4:	∇DC	50 V		
5:	∇DC	50 V		
6:	∇DC	50 V		
7:	∇DC	50 V		

Note: For voltage measurement, select "DC".

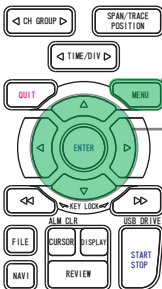

1. Press the MENU key to display the setup menu screen.

2. Select "TEMP." for the Input parameter for CH 1 and CH 2.

- Move the cursor to the input parameter opposite CH 1 and select "TEMP."
- Make the same setting for CH 2.

AMP	DATA	TRIG	USER	I/F
Making analog and pulse				
· Display Logic/Pulse Da				
CH:	Input	Range		
ALL:	∇DC	50 V		
1:	∇DC	50 V		
2:	∇DC	50 V		
3:	∇DC	50 V		
4:	∇DC	50 V		
5:	∇DC	50 V		
6:	∇DC	50 V		
7:	∇DC	50 V		

AMP	DATA	TRIG	USER	I/F
Making analog and pulse				
· Display Logic/Pulse Da				
CH:	Input	Range		
ALL:	∇DC	50 V		
1:	∇DC	50 V		
2:	Off	50 V		
3:	∇DC	50 V		
4:	∇TEMP	50 V		
5:	∇RH	50 V		
6:	∇DC	50 V		
7:	∇DC	50 V		

AMP	DATA	TRIG	USER	I/F
Making analog and pulse				
· Display Logic/Pulse Da				
CH:	Input	Range		
ALL:	∇TEMP	TC-K		
1:	∇TEMP	TC-K		
2:	∇DC	50 V		
3:	∇DC	50 V		
4:	∇DC	50 V		
5:	∇DC	50 V		
6:	∇DC	50 V		
7:	∇DC	50 V		

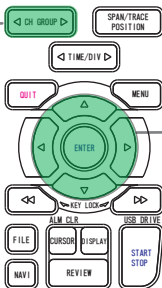

3. Select "TC-T" for the Range parameter for CH 1 and CH 2.

- Move the cursor to the Range parameter opposite CH 1 and select "TC-T".
- Make the same setting for CH2.

AMP	DATA	TRIG	USER	I/F	OTHER	USER	USER
Making analog and pulse/logic settings							
· Display Logic/Pulse Data: >							
CH:	Input	Range	Filter	EU	Misc.		
ALL:	∇TEMP	TC-K	Off				
1:	∇TEMP	TC-K	Off				
2:	∇DC	TC-K	TC-W				
3:	∇DC	TC-J	Pt100				
4:	∇DC	TC-T	JPT100				
5:	∇DC	TC-R	PT1000				
6:	∇DC	TC-E					
7:	∇DC	TC-B					
8:	∇DC	TC-S					
9:	∇DC	TC-N					
10:	∇DC	50 V	Off				

4. Select "Off" for all the other channels.

- Using the procedure described above, select "Off" for CH 3 to CH 10.
- Use the CH GROUP key to switch to the CH11 to CH20 group.

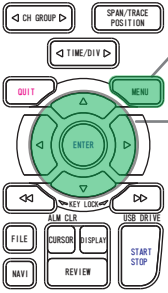

5. Press the MENU key and open the "DATA" menu.

6. Set the sampling interval to "1s".

Move the cursor to "Sampling" and then select "1s".

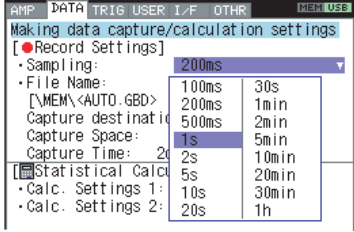

7. Specify the Capture Destination file name.

Here we will create a folder named "TEST" in the USB memory device, and then make the settings required to enable data to be captured to the TEST folder.

- (a) Move the cursor to the File Name parameter and then press the ENTER key.
- (b) With the cursor on the <MEM> item in the following screen, press the ENTER key.

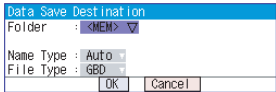

- (c) The file settings box shown in the following screen opens. This box is used to specify file names for the GL800's internal memory and for the USB memory device.

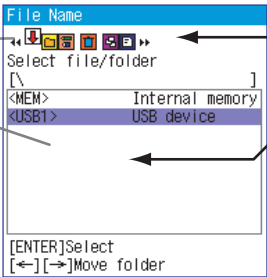
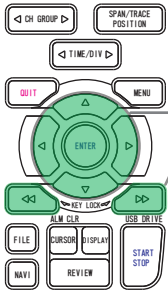
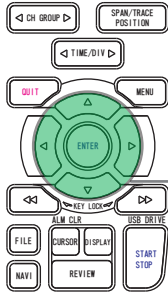

Use the high-speed <<< and >>> keys to change the operation mode.

In the Select file/folder screen displayed,

- Use the Δ and ∇ keys to move the cursor up or down.
- Use the < and > keys to move to the Folder level.
- Use the ENTER key to confirm your setting.
- Use the QUIT key to cancel your setting.

- (d) Move the cursor to <USB1> and then press the > key.
- (e) Press the >>> key to move the cursor to "Create new folder" and then press the ENTER key.

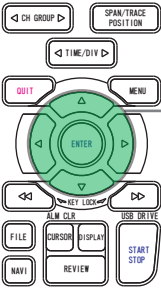

(f) A text input box is displayed. Let's create a folder named "TEST".

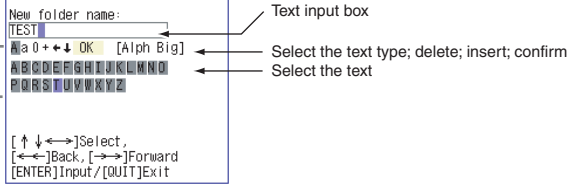

- (g) Input "TEST", move the cursor to "OK", and then press the ENTER key to confirm your setting.
- (h) As shown in the following screen, a folder named <TEST> has been created. Press the <<< key to align the cursor with "Select file/folder", use the Δ and ∇ keys to align the cursor with the <TEST> folder, and then press the ENTER key.

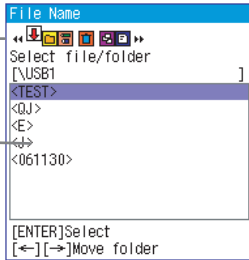
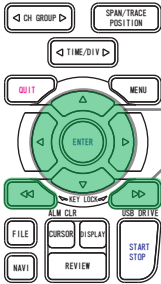

(i) Check that "<TEST>" appears opposite "Folder", move the cursor to the OK button, and then press the ENTER key.

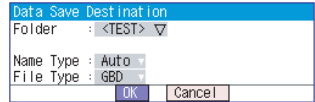
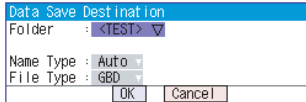

(j) In the screen displayed below, we can check the capture destination, the amount of data that can be captured, and the allowable data capture time.

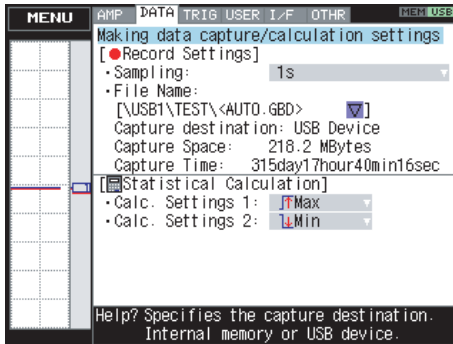

This completes all the settings required for data capture.

3. Data Capture : How to Measure the Temperature

Now that all the data capture settings have been made, we will start actual data capture. During the data capture operation, let's also replay some data that was captured previously.

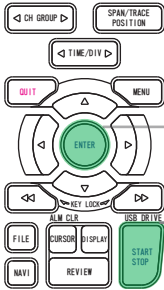

1. Starting data capture

- Press the START/STOP key.
- A confirmation message is displayed.

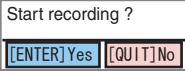

- Press the ENTER key to start data capture.

2. Screen status during data capture

Once data capture has started, the elapsed time and the allowable data capture time are counted.

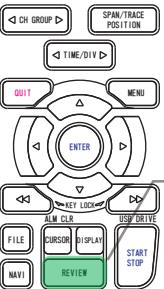
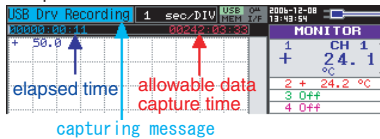

3. Now, let's replay some data that was captured previously (2-screen replay).

Data that was captured in the past can be replayed while new data is being captured to the GL800. In addition, the past data can be compared with the current input waveform in a 2-screen format.

- Press the REVIEW key to display the data in a 2-screen format.

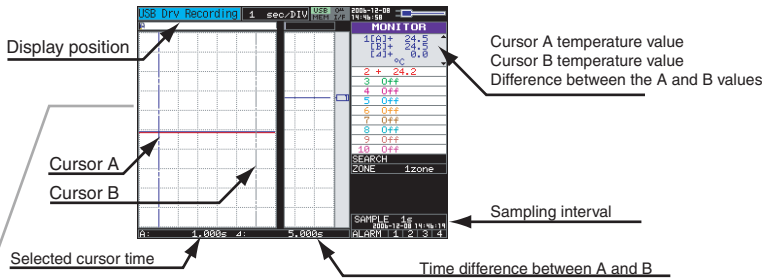

<Main operations>

- Use the < and > keys to move the cursor
 - Use the << and >> keys to move the cursor at high speed
 - Use the CURSOR key to change your cursor selection (A→B→A)
- Move the cursor as desired to check the captured waveforms, date/time, and so forth.

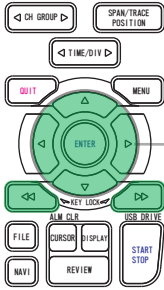

4. Stopping data capture

Press the START/STOP key to end the data capture operation.

- Press the START/STOP key.

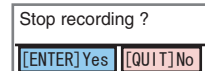

- A confirmation message is displayed. Press the ENTER key.
- Data capture ends, and the GL800 goes into the Free Running status.

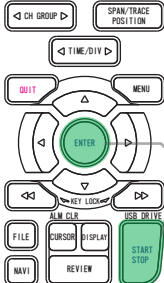

This completes the data capture operation.

4. Data Replay : How to Replay Captured Data

Now that data capture has been completed, let's replay some of that captured data. The data has been captured to the <TEST> folder that was created in the USB memory device in Step 7 of Section 2, "Setup". The file name is appended automatically, and therefore the name of the file that was created is "Year/month/date-time_UG.gbd". The year/month/date and time are those that were in effect when data capture started.

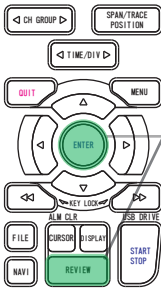

1. Selecting a file to replay

- (a) Press the REVIEW key.
- (b) Since the file you want to replay has the file name that was appended automatically when the data was captured, move the cursor to the OK button and then press the ENTER key.

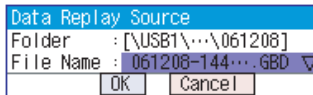

- (c) The Replay screen opens.

See Step 3 of Section 3, "Data Capture".

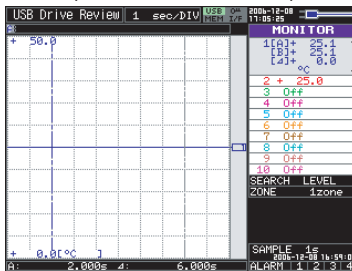

- (d) Move the cursor as desired to check the captured waveforms, date/time, and so forth. The SPAN/POSITION/TRACE key can also be used in the Replay screen to change the span, position trace, zone and other displayed settings.
- (e) Press the QUIT key to end the data replay operation. A confirmation message is displayed. Press the ENTER key.

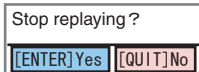

- (f) Data replay ends, and the GL800 goes into the Free Running status.

This completes our simple explanation of how to use the basic GL800 functions. The GL800 has many other convenient functions. Please see the next five pages for further details.

GL800 Convenient Functions

The GL800 is provided with various functions that enable it to be used more effectively. We have selected three of those functions to describe in further detail.

Trigger Functions to Control Data Capture Start/Stop Operations

Trigger functions can be used to control the timing of the start of a data capture operation, and the timing of the end of a data capture operation.

Points to Remember

For example... You can use trigger functions to perform operations such as the following:

- Start data capture when the voltage exceeds 1 V
- Stop data capture at 1:00 pm
- Perform control via external input

Here we will specify the condition as "Start data capture when the CH 1 temperature exceeds 20°C".

(1) Press the MENU key and open the "TRIG" menu.

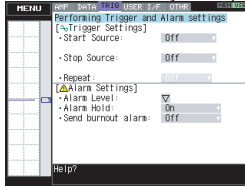
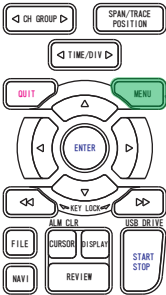

(2) Move the cursor to "Start Source" and select "Level".

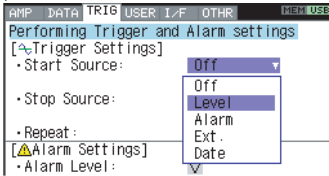
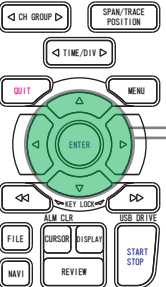

(3) Align the cursor with "Level" and then press the ENTER key to open the "Trigger Level Settings" screen.

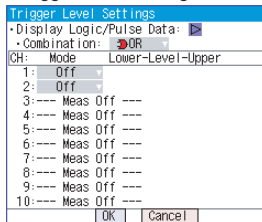

(4) Move the cursor to the "Mode" parameter opposite CH 1, and then select "H".

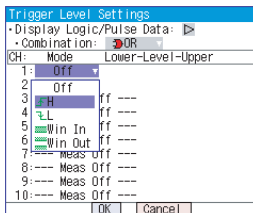
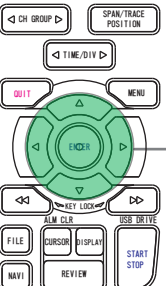

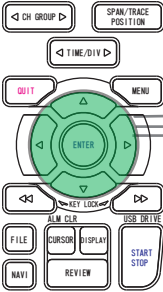

(5) Move the cursor to the "Level" parameter next to the "Mode"

(6) The input box shown in the following screen is displayed. Select "20". Use the < and > keys to move to the cursor to the second digit from the right, and the Δ and ∇ keys to change the value. Press the ENTER key.

Set Value: + 20
Limits: [- 270, +2000]
[ENTER]Register

- Numerical value input box
- Waveform area for confirmation
- Lower limit, upper limit
- Use the ∇ and Δ keys to change the values.
- Use the < and > keys to move to the next digit.
- Use the ENTER key to input the name.
- Use the QUIT key to cancel your setting .

(7) When the screen changes to the following screen, move the cursor to the OK button and then press the ENTER key.

Trigger Level Settings
• Display Logic/Pulse Data: ▶
• Combination: OR
CH: Mode Lower-Level Upper
1: FH 20 °C
2: Off
3:--- Meas Off ---
4:--- Meas Off ---
5:--- Meas Off ---
6:--- Meas Off ---
7:--- Meas Off ---
8:--- Meas Off ---
9:--- Meas Off ---
10:--- Meas Off ---
OK Cancel

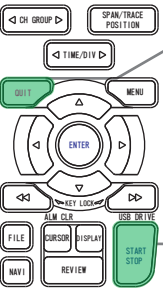

(8) The screen returns to the TRIG menu screen. Press the QUIT key to return the GL800 to the Free Running status.

(9) Now let's press the START/STOP key to start data capture. If the trigger condition has not been satisfied, the GL800 goes into the "Armed" status as shown on the following screen.

Armed
00:00:00
+ 50.0

When the trigger condition has been satisfied, data capture starts.

USB Drv Recording
00:00:01:27
+ 50.0

Span, Position and Trace Functions to Adjust the Waveform Display

These functions enable you to make adjustments in order to view individual channels more easily, and to delete waveforms that you do not need to view.

Points to Remember

The span, position and trace operations can be performed while the GL800 is in the Free Running status, while it capturing data, and while it is replaying data. The changes made are applied to the displayed data only, and so the original data is not affected in any way.

1. How to Make a Span setting.

The Span parameter is used to adjust the amplitude of the input waveform. This setting is made in the aforementioned Free Running status.

- Adjust the span display width for CH 1 to 100°C.
- Press the SPAN/POSITION/TRACE key to select the SPAN mode.

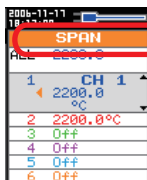

The currently selected mode (SPAN, POSITION or TRACE) can be checked by looking at the "Waveform Operation Display Area".

- Use the ∇ and Δ keys to make CH 1 active (enlarged display).
- Use the \triangleleft and \triangleright keys to change the Span value. Here we will set the value to 100°C. When this setting has been made, the waveform screen scale will be set to "+100.0 to +0.0".

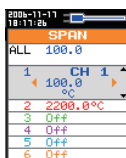

2. How to make a Position setting.

The Position parameter is used to adjust the zero position's upper and lower positions for the input waveform.

- Press the SPAN/POSITION/TRACE key to select the POSITION mode.
- Use the ∇ and Δ keys to make CH 1 active (enlarged display).
- Use the \triangleleft and \triangleright keys to set the Position value to "+80°C to -20°C".

When this setting has been made, the waveform screen scale will be set to "+80°C to -20°C".

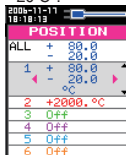

3. How to make a Trace setting.

The Trace parameter can be used to specify the waveform display of selected channels as On or Off.

- Press the SPAN/POSITION/TRACE key to select the TRACE mode.
- Use the ∇ and Δ keys to make CH 2 active (enlarged display).
- Use the \triangleleft and \triangleright keys to select Off.

When this setting has been made, the CH 2 waveform is not displayed.

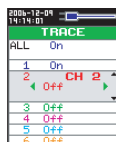

GL800 Specifications

Standard Specifications

Item	Description				
Number of analog terminal units	1 unit (20 channels) or extension unit (maximum 200 channels)				
External input and output functions	Trigger input, Logic input, Pulse input, Alarm output				
PC interface	Ethernet (10BASE-T/100BASE-TX), USB (HighSpeed supported) provided as standard features				
Built-in memory device	Internal memory : Approx.12MB USB memory slot (FullSpeed supported) is provided as a standard feature				
Sampling interval	100ms/10CH MAX 100 · 200 · 500ms · 1 · 2 · 5 · 10 · 20 · 30sec 1 · 2 · 5 · 10 · 20 · 30min · 1hour				
Back-up functions	Setup parameters: EEPROM/Clock: Lithium secondary battery				
Clock accuracy (ambient temperature 23°C)	±0.002% (approx. 50 seconds per month)				
Operating environment	0 to 45°C, 5 to 85% RH(15 to 40°C when using batteries)				
Power supply	AC adapter : 100 to 240 VAC, 50 to 60 Hz DC input : 8.5 to 24 VDC Battery pack (option) : 7.2 VDC (2200 mAh), 2 packs mountable				
Power consumption	• AC power consumption (when using the AC adapter provided as a standard accessory)				
	No	Condition	Normal	During battery recharge	
	1	When the LCD is on	16VA	28VA	
	2	When the screensaver is operating	11VA	22VA	
	• DC current consumption				
	No	Condition	Normal	During battery recharge	
	1	+24V	When the LCD is on	0.3A	0.7A
	2		When the screensaver is operating	0.2A	
	3	+12V	When the LCD is on	0.55A	Recharging not possible
	4		When the screensaver is operating	0.3A	
	5	+8.5V	When the LCD is on	0.8A	Recharging not possible
	6		When the screensaver is operating	0.45A	
*Normal status is when LCD brightness is set to MAX.					
External dimensions	232×152×50mm				
Weight ^{*1}	990g				
Vibration-tested conditions	Equivalent to automobile parts Type 1 Category A classification				

*1: Excluding the AC adapter and battery. Including one terminal unit.

External Input/Output Functions

Item	Description			
Input specifications (pulse/logic, trigger)	Maximum input voltage : 0 to +24 V (single-ended ground input)			
	Input threshold voltage : approx. +2.5 V			
	Hysteresis : approx. 0.5 V (+2.5 V to +3 V)			
Alarm output specifications	Output format : Open collector output (5 V, 10 KΩ pull-up resistance) : Contact capacity 5 V to 24 V, 100 mA or below			

Input Unit Specifications

Item	Description																																																													
Number of input channels	M3 screw type, 20 channels (maximum 200 channels with extension unit)																																																													
Method	Photo MOS relay scanning system, all channels isolated, balanced input																																																													
Measurement ranges	<table border="0"> <tr> <td>Voltage</td> <td>20 · 50 · 100 · 200 · 500mV, 1 · 2 · 5 · 10 · 20 · 50, 1-5VFS.</td> </tr> <tr> <td>Temperature</td> <td>Resistance temperature detector : K, J, E, T, R, S, B, N, W(WRe5-26)</td> </tr> <tr> <td>Humidity</td> <td>: Pt100, JPt100, Pt1000(IEC751)</td> </tr> </table>	Voltage	20 · 50 · 100 · 200 · 500mV, 1 · 2 · 5 · 10 · 20 · 50, 1-5VFS.	Temperature	Resistance temperature detector : K, J, E, T, R, S, B, N, W(WRe5-26)	Humidity	: Pt100, JPt100, Pt1000(IEC751)																																																							
Voltage	20 · 50 · 100 · 200 · 500mV, 1 · 2 · 5 · 10 · 20 · 50, 1-5VFS.																																																													
Temperature	Resistance temperature detector : K, J, E, T, R, S, B, N, W(WRe5-26)																																																													
Humidity	: Pt100, JPt100, Pt1000(IEC751)																																																													
Thermocouples	0 to 100% (voltage 0 V to 1 V scaling conversion) *with B-530 (option)																																																													
Measurement accuracy ¹	±0.1% of F.S.																																																													
	<ul style="list-style-type: none"> •Thermocouple <table border="1"> <thead> <tr> <th>Type</th> <th>Measurement Temperature Range</th> <th>Measurement Accuracy</th> </tr> </thead> <tbody> <tr> <td rowspan="4">R/S</td> <td>0 ≤ TS ≤ 100</td> <td>±5.2°C</td> </tr> <tr> <td>100 < TS ≤ 300</td> <td>±3.0°C</td> </tr> <tr> <td>R : 300 < TS ≤ 1600</td> <td>± (0.05% of rdg + 2.0°C)</td> </tr> <tr> <td>S : 300 < TS ≤ 1760</td> <td>± (0.05% of rdg + 2.0°C)</td> </tr> <tr> <td rowspan="2">B</td> <td>400 ≤ TS ≤ 600</td> <td>±3.5°C</td> </tr> <tr> <td>600 < TS ≤ 1820</td> <td>± (0.05% of rdg + 2.0°C)</td> </tr> <tr> <td rowspan="2">K</td> <td>-200 ≤ TS ≤ -100</td> <td>± (0.05% of rdg + 2.0°C)</td> </tr> <tr> <td>-100 < TS ≤ 1370</td> <td>± (0.05% of rdg + 1.0°C)</td> </tr> <tr> <td rowspan="2">E</td> <td>-200 ≤ TS ≤ -100</td> <td>± (0.05% of rdg + 2.0°C)</td> </tr> <tr> <td>-100 < TS ≤ 800</td> <td>± (0.05% of rdg + 1.0°C)</td> </tr> <tr> <td rowspan="2">T</td> <td>-200 ≤ TS ≤ -100</td> <td>± (0.1% of rdg + 1.5°C)</td> </tr> <tr> <td>-100 < TS ≤ 400</td> <td>± (0.1% of rdg + 0.5°C)</td> </tr> <tr> <td rowspan="3">J</td> <td>-200 ≤ TS ≤ -100</td> <td>±2.7°C</td> </tr> <tr> <td>-100 < TS ≤ 100</td> <td>±1.7°C</td> </tr> <tr> <td>100 < TS ≤ 1100</td> <td>± (0.05% of rdg + 1.0°C)</td> </tr> <tr> <td>N</td> <td>0 ≤ TS ≤ 1300</td> <td>± (0.1% of rdg + 1.0°C)</td> </tr> <tr> <td>W</td> <td>0 ≤ TS ≤ 2315</td> <td>± (0.1% of rdg + 1.5°C)</td> </tr> </tbody> </table> <p>Reference contact compensation accuracy : ±0.5°C</p> <p><i>*1: Thermocouple diameters T: 0.32 φ, others: 0.65 φ</i></p> <ul style="list-style-type: none"> •Resistance temperature detector <table border="1"> <thead> <tr> <th>Type</th> <th>Measurement Temperature Range</th> <th>Applied current</th> <th>Accuracy</th> </tr> </thead> <tbody> <tr> <td>Pt100</td> <td>-200~850°C</td> <td>1mA</td> <td>±1.0°C</td> </tr> <tr> <td>JPt100</td> <td>-200~500°C</td> <td>1mA</td> <td>±0.8°C</td> </tr> <tr> <td>Pt1000</td> <td>-200~500°C</td> <td>0.2mA</td> <td>±0.8°C</td> </tr> </tbody> </table> 	Type	Measurement Temperature Range	Measurement Accuracy	R/S	0 ≤ TS ≤ 100	±5.2°C	100 < TS ≤ 300	±3.0°C	R : 300 < TS ≤ 1600	± (0.05% of rdg + 2.0°C)	S : 300 < TS ≤ 1760	± (0.05% of rdg + 2.0°C)	B	400 ≤ TS ≤ 600	±3.5°C	600 < TS ≤ 1820	± (0.05% of rdg + 2.0°C)	K	-200 ≤ TS ≤ -100	± (0.05% of rdg + 2.0°C)	-100 < TS ≤ 1370	± (0.05% of rdg + 1.0°C)	E	-200 ≤ TS ≤ -100	± (0.05% of rdg + 2.0°C)	-100 < TS ≤ 800	± (0.05% of rdg + 1.0°C)	T	-200 ≤ TS ≤ -100	± (0.1% of rdg + 1.5°C)	-100 < TS ≤ 400	± (0.1% of rdg + 0.5°C)	J	-200 ≤ TS ≤ -100	±2.7°C	-100 < TS ≤ 100	±1.7°C	100 < TS ≤ 1100	± (0.05% of rdg + 1.0°C)	N	0 ≤ TS ≤ 1300	± (0.1% of rdg + 1.0°C)	W	0 ≤ TS ≤ 2315	± (0.1% of rdg + 1.5°C)	Type	Measurement Temperature Range	Applied current	Accuracy	Pt100	-200~850°C	1mA	±1.0°C	JPt100	-200~500°C	1mA	±0.8°C	Pt1000	-200~500°C	0.2mA	±0.8°C
Type	Measurement Temperature Range	Measurement Accuracy																																																												
R/S	0 ≤ TS ≤ 100	±5.2°C																																																												
	100 < TS ≤ 300	±3.0°C																																																												
	R : 300 < TS ≤ 1600	± (0.05% of rdg + 2.0°C)																																																												
	S : 300 < TS ≤ 1760	± (0.05% of rdg + 2.0°C)																																																												
B	400 ≤ TS ≤ 600	±3.5°C																																																												
	600 < TS ≤ 1820	± (0.05% of rdg + 2.0°C)																																																												
K	-200 ≤ TS ≤ -100	± (0.05% of rdg + 2.0°C)																																																												
	-100 < TS ≤ 1370	± (0.05% of rdg + 1.0°C)																																																												
E	-200 ≤ TS ≤ -100	± (0.05% of rdg + 2.0°C)																																																												
	-100 < TS ≤ 800	± (0.05% of rdg + 1.0°C)																																																												
T	-200 ≤ TS ≤ -100	± (0.1% of rdg + 1.5°C)																																																												
	-100 < TS ≤ 400	± (0.1% of rdg + 0.5°C)																																																												
J	-200 ≤ TS ≤ -100	±2.7°C																																																												
	-100 < TS ≤ 100	±1.7°C																																																												
	100 < TS ≤ 1100	± (0.05% of rdg + 1.0°C)																																																												
N	0 ≤ TS ≤ 1300	± (0.1% of rdg + 1.0°C)																																																												
W	0 ≤ TS ≤ 2315	± (0.1% of rdg + 1.5°C)																																																												
Type	Measurement Temperature Range	Applied current	Accuracy																																																											
Pt100	-200~850°C	1mA	±1.0°C																																																											
JPt100	-200~500°C	1mA	±0.8°C																																																											
Pt1000	-200~500°C	0.2mA	±0.8°C																																																											
A/D converter	16Bit (out of which 14 bits are internally acknowledged)																																																													
Temperature coefficient	Gain : 0.01% of F.S./ °C																																																													
Input resistance	1MΩ±5%																																																													
Allowable signal source resistance	Within 300 Ω																																																													
Maximum input voltage	Between +/- terminals, each channels, CH-GND : 60 Vp-p																																																													
Withstand voltage	Between each input channels, and CH-GND : 1 minute at 350 Vp-p																																																													
Insulation resistance	CH-GND : At least 50M Ω (at 500 VDC)																																																													
Common mode rejection ratio	At least 90 dB (50/60 Hz; signal source 300 Ω or less)																																																													
Noise	At least 48 dB (with +/- terminals shorted)																																																													

GL800 Installation Guide

This section explains how to install the environment settings tool and GL800 application software.

<System Requirements>

This software can be installed on a PC which fulfills the following conditions.

OS	: Windows 2000, XP
CPU	: Pentium4, 1.7 GHz or higher
Memory	: 256 MB or more (512 MB recommended)
HDD	: 100 MB (1 GB recommended) additional space required for installing the application software
Display	: Resolution 1024 x 768 or higher, 65535 colors or above (16 Bit or higher)
Others	: CD-ROM drive (for installing from CD), USB port required

<To Install the USB Driver>

To install the USB driver, follow the directions below.

- (1) Insert the accompanying midi LOGGER GL800 CD-ROM in the PC's CD drive.
- (2) Connecting the PC and GL800.
Connect the PC and GL800 via a USB cable and power on the GL800.
- (3) Installing the USB driver
The "Found New Hardware" message appears, followed by the Install New Hardware wizard for the environment settings tool.
Follow the directions displayed by the installer.
Choose "USB Driver" for driver selection.
The driver is located in the "USB Driver".

<To Install the Application Software>

To install the application software which sets and controls the GL800, follow the directions below.

- (1) Insert the accompanying midi LOGGER GL800 CD-ROM in the PC's CD drive.
- (2) Select [Start] ? [Run] to open the [Run] window.
- (3) In the [Open:] field, type in "D:\Japanese\midi LOGGER Software\SETUP.EXE" and press [OK]. The installer starts.
("D:" represents the CD-ROM drive. Change this letter to the drive letter representing your CD-ROM drive, if necessary.)
- (4) Follow all directions displayed by the installer to continue.

GRAPHTEC

- Specifications are subject to change without notice.

GL800 Quick Start Guide
(GL800-UM-851)

March 1, 2007
1st edition-01

GRAPHTEC CORPORATION